

MOUNTING, OPERATING, TESTING & MAINTENANCE INSTRUCTIONS FOR ROTEX 2/2 INTERNAL PILOT, POPPET TYPE, NORMALLY OPEN SOLENOID VALVE MODEL 21201, 21202, 21203

ROTEX retains all rights to this publication.

All details within this manual and the catalogue are subject to change without manner.

ROTEX will not be responsible for any damage whatsoever arising from the use of the Solenoid Valve, due to misuse or incorrect installation or misinterpretation of the information contained herein.

CONNECTION

| VALVE TYPE | FUNCTION | IN | OUT |
|---------------------|----------|----|-----|
| 21201, 21202, 21203 | NO | 2 | 1 |

(A) OPERATING PRINCIPLE

In de-energized condition of the solenoid, pressure applied at the inlet port # 2, media passed from pilot hole to pilot vent to tubing to outlet port # 1. In this state inlet port # 2 and outlet # 1 is connected by external tubing. Thus media come out from the outlet port #1.

In energized condition of the solenoid, plunger moves up, and blocked pilot vent hole. Hence, media pressure act on the piston through the pilot and Duse hole. So piston assembly moves downwards. In this state inlet port # 2 and outlet port # 1 is disconnected. Media cannot come out.

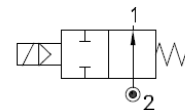
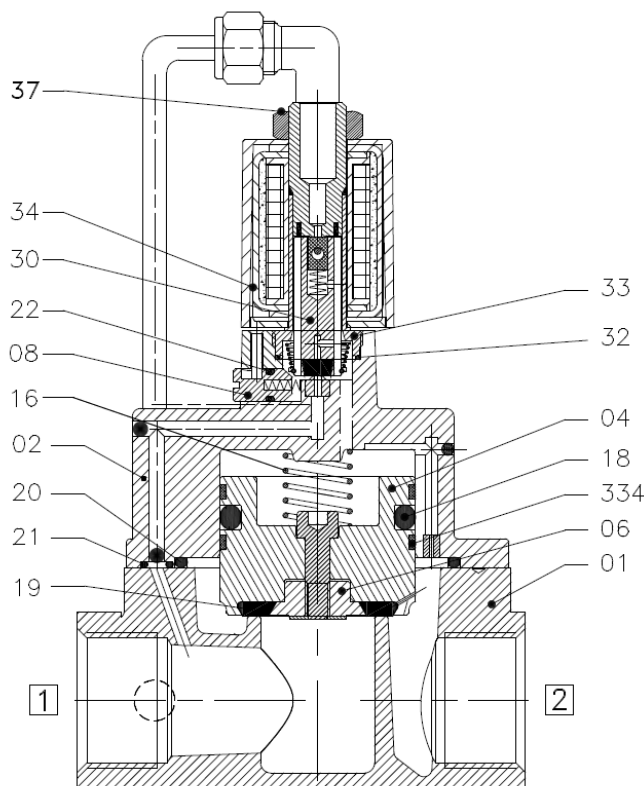

| | | |
|------|------------------------------|--------|
| 02 | PISTON GLYDRING | 334 |
| 01 | NUT | 37 |
| 01 | COIL ASSLY. | 34 |
| 01 | GUIDE ASSLY. | 33 |
| 01 | GUIDE 'O' RING | 32 |
| 01 | PLUNGER ASSLY. | 30 |
| 01 | MA 'O' RING | 22 |
| 01 | PILOT 'O' RING | 21 |
| 01 | BODY 'O' RING | 20 |
| 01 | PISTON 'O' RING | 18 |
| 01 | SEAT 'O' RING | 19 |
| 01 | VENTILFEDER (SPRING) | 16 |
| 01 | MANUAL ACTUATOR | 08 |
| 01 | DRUCKSCHEIBE (PRESSURE DISC) | 06 |
| 01 | KOLBEN (PISTON) | 04 |
| 01 | DECKEL (COVER) | 02 |
| 01 | GEHAUSE (BODY) | 01 |
| QTY. | DESCRIPTION | POS.No |

IDENTIFICATION ON THE SOLENOID VALVE

a) VALVE MARKING

Label on the **ROTEX** Solenoid Valve shows the following details:

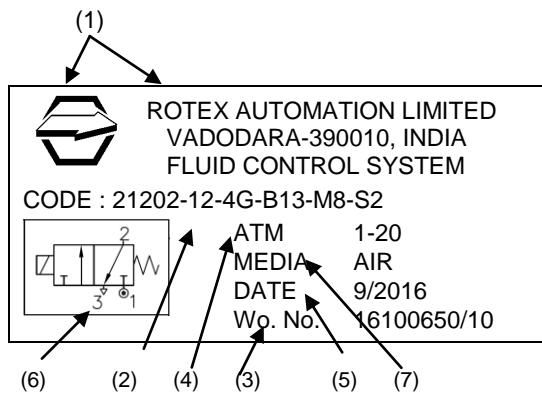

- (1) Logo + Name & address of the Manufacturer
- (2) Valve Type / Code
 - 21202 = Valve Model
 - Suffix = Nil
 - 12 = Orifice Ø
 - 4G = Port Connection
 - B13 = Body Material
 - M8 = Manual Override
 - S2 = Seal Material
- (3) Work Order reference / Sr. No. of the Valve
- (4) Operating Pressure
- (5) Month & Year of manufacture
- (6) Valve Symbol
- (7) Media

b) SOLENOID MARKING

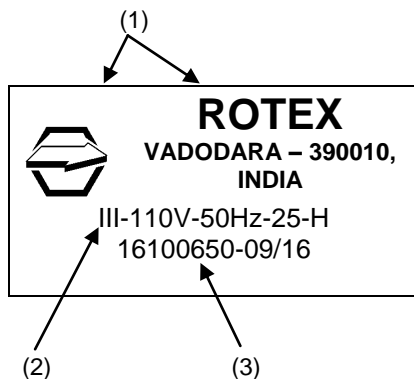

- (1) Logo + Name of the Manufacturer
- (2) Solenoid Type
 - III = Solenoid Size III
 - 110V = Solenoid Voltage
 - 50 Hz = Solenoid Current
 - 25 = Solenoid Construction
 - H = Solenoid Class H Insulation
- (3) Work order No. Manufacturing Month / Year

c) PORT IDENTIFICATION

A solenoid Valve with NPT (F) threading is normally marked "N" near the port and with Metric threads are marked "M". For ports with BSP threads, there is no marking.

d) Voltage, current & other details are additionally marked/ punched on the solenoid.

⚠ NOTE: The product without label is out of warranty and risk.





(B) MOUNTING/INSTALLATION PROCEDURE:

1. ENSURE THAT:





- a) While storing, keep the valve in cool, dry, dust free area.
- b) On receipt of the valve, in case if the same is to be removed from the sealed plastic bag for inspection/testing, put them back with dust plugs on its ports and sealing the plastic bag as soon as the inspection/testing is over.
- c) The valve should be removed from its card board and/or plastic bag just before the installation.
- d) Flush lines before installing the valve.
- e) To avoid pressure drop and to achieve optimum parameters, Pipe / Tube / Fitting from the source of pressure to the valve and to the connected equipment should have ID which is \geq NW (Orifice) of the valve.
- f) To avoid pressure drop, if more than one valve is being operated simultaneously from a common header, then minimum ID of the header can be calculated as under.

$$ID \text{ Header} = \sqrt{NW^2 \times n}$$
 n = Number of Valves operating at a time and which are connected to a common header,
 NW = Orifice of the Valve.
- g) Incorporate filter in the line to avoid hard particles entering into the valve.
- h) The valve should be installed for the media for which it is intended for. This is to avoid the malfunction of

Seals and the valve in case if you intend to use valve for media other than the one specified on that valve, check compatibility of media to Body Seal material and grease. Consult **ROTEX** in case if any doubt.

- i) Do not try to drill any additional holes or machine, modify any of the valve components.
 -  j) In case if the valve is used for dangerous fluid gas/liquid then, the user is hereby advised to maintain during operation and maintenance of the valve below LEL or above UEL to avoid explosion due to internal spark as the valves have not been assessed for the same.
 - k) Inlet pressure does not exceed rated pressure.
 - l) Hemp-Filaments, 'Jute' or even Teflon-Ribbons are normally not required, as the port connections of ROTEX Valve is accurately machined.
 - m) To avoid overlap of the Teflon ribbon or cuts generated while tightening, getting carried away into the valve. Do not cover first two thread pitches with Teflon tape or sealant.
2. The process fluid etc. do not fall on the valve body.
 3. In case if the surrounding atmosphere has traces or some other substance other than Air, check its compatibility with the Body material of the valve, Solenoid enclosure & other exposed parts.
 -  4. In case if the valve is installed in potentially Hazardous area, check for the temperature class of the Solenoid to avoid explosion due to heated Solenoid / other components.
 -  5. Provide fuse of proper rating to avoid excess current passing through the Solenoid and thereby avoiding over heating.
 -  6. It is not likely however the user is advised to protect the valve against lightening as the same is not assessed.
 7. Check internal components (wetted) parts for its compatibility with fluid passing through the valve.

ELECTRICAL

1. Verify name plate/ marking affixed on the Solenoid.
2. Connect the power supply according to the voltage rating of the Solenoid.
3. Ensure that the cover of Junction Box/Terminal Box is properly tightened wherever applicable.
-  4. Install valve in such a way that the rain water / other process fluid dripping along the cable does not fall on the SOV and has no possibility to run along the cable and enter into the Terminal area.
5. Fill in the space between cable and gland entry with a proper sealant. If necessary, you may mount the valve upside down or in any other direction.
6. Ensure that the Solenoid enclosure meets process and local authority requirement.
7. The Plug In, Terminal Box, FPJB, IS Solenoids are provided with test leads. Remove them before final installation.
-  8. Check for proper connections for the Solenoid which are polarity sensitive e.g. (a) Latched Solenoid (b) Ex ia Solenoid.
-  9. Refer separate manual for construction of the Solenoid and for specific instructions related to Solenoid e.g. (a) Ex ia (b) Latched Solenoid (c) Exd Solenoid IP 67.
10. Ensure that the solenoid construction is selected properly meeting the environment in which the valve is supposed to be installed e.g. use of Exd or Ex ia solenoid for valve to be installed in hazardous location or Weatherproof Solenoid having IP 67 for outdoor installation.
-  11. Flying Lead Solenoid is not recommended to be used for outdoor or indoor application where water/liquid splashing or high humidity is present.

MANUAL OVERRIDE OPERATION

(A) PUSH & TURN TYPE (M6)

In normal condition of the manual override, pressure applied at the inlet port # 2, media passed from pilot hole to pilot vent to tubing to outlet port # 1. In this state inlet port # 2 and outlet #1 is connected by external tubing. Thus media come out from the outlet port #1. Media comes out.

To operate the manual override, push and turn clockwise, thus plunger moves up, and blocked pilot vent hole. Hence, media pressure act on the piston through the pilot and Duse hole. So piston assembly moves downwards. In this state inlet port # 2 and outlet port # 1 is disconnected. Media cannot come out. To retain the valve at home positions push and turn anticlockwise.

(B) PUSH TYPE (M8)

In normal condition of the manual override, pressure applied at the inlet port # 2, media passed from pilot hole to pilot vent to tubing to outlet port # 1. In this state inlet port # 2 and outlet #1 is connected by external tubing. Thus media come out from the outlet port #1. Media comes out.

To operate the manual override, push it, thus plunger moves up, and blocked pilot vent hole. Hence, media pressure act on the piston through the pilot and Duse hole. So piston assembly moves downwards. In this state inlet port # 2 and outlet port # 1 is disconnected. Media cannot come out. To retain the valve at home positions release it.

TESTING OF THE VALVE AT THE TEST BENCH

- ⚠ Check at least once in 3 years or following your routine maintenance schedule.
 - a) Apply rated pressure at inlet port of the valve.
 - b) Plug outlet ports.
 - c) Check operation of the valve and leakage at the outlet ports and joints at the rated and minimum working pressure by applying 75% to 120% rated voltage.
 - d) While keeping the solenoid de-energized, check operation and leakage at the outlet ports joints of the valve at the rated and minimum working pressure by operating Manual Override.

- ⚠ Check at least once in 3 years or following your routine maintenance schedule.
 - a) Apply rated pressure at inlet port of the valve.
 - b) Plug outlet ports.
 - c) Check operation of the valve and leakage at the exhaust ports and pilot vent at the rated and minimum working pressure by applying 75% to 120% rated voltage.
 - d) While keeping the solenoid de-energized, check operation and leakage from exhaust and pilot vent ports of the valve at the rated and minimum working pressure by operating Manual Override.

- ⚠ e) Without connecting air supply to the valve, operate Manual Override. Energize and De-energize Solenoid to check for the plunger movement (normally movement should not be there) which can be checked by click sound. After operating Manual Override if plunger movement is found, reduce length of the manual override by 0.3mm from its taper end. Continue this till click sound stops.
- f) Check the insulation resistance of the Solenoid by applying 500V DC at terminals and the solenoid housing. It should be more than 100 Mega Ohms.

RECOMMENDED SPARES

- a) Seal Kit (O Rings + Plunger Assembly)
- b) Spare Solenoid.

RECOMMENDED MAINTENANCE

- Replacement of Complete Set of O Ring
 - Seat O Ring, Piston o Ring, Body O Ring,
 - Pilot o Ring, MA O Ring, Guide O Ring,
 - Piston Glydering
- Replacement of Plunger Assembly
- Replacement of the Solenoid
- Check of Insulation Resistance,
- Check Resistance of the Solenoid

PREVENTIVE

- Once in 5 years or 2 million operations.
- Once in 5 years or 2 million operations
- As and when required.
- Once in a year (should be ≥ 100 M Ohms @ 500V DC.
- Replace Solenoid if the resistance reduces more than 5% computed at 20°C as compared to its Initial value.

MAINTENANCE – GENERAL INSTRUCTION

- The Solenoid Valve must be removed from the site and has to be maintained under safe conditions.
- ⚠ • All air and electrical connections must be switched off before removing valve from the line.
- ⚠ • It is recommended to replace complete set of O Ring even if one of the O Ring is damaged. This is to ensure trouble free operation of the valve and will avoid its premature failure.
- Using Grease other than Silicon base Molykote M55 will lead to premature failure of O Rings of the **ROTEX** Solenoid valve.
- ⚠ • If necessary to clean the components, **do not use Kerosene, Diesel, Petrol to clean valve as this damages the O Rings and other rubber material. Instead use light Detergent Soap Solution.**
- Ensure that the components are free from dust, dirt, lint and metal burrs.
- Twisting of O Ring should be avoided. Ensure that the twist is removed before fitting matching part.
- While closing the matching part, the matching part should be pushed in a straight line. Turning motion should be avoided.
- Pinching of O Ring at the groove corner at the time of closing gland should be avoided.
- User is requested to use safe practice for maintenance.
- It is important to place the dismantled Valve Parts on a clean paper or cloth in same sequence in which you have dismantled them.
- Ensure to keep all the components of the valve separately to avoid their mixing up. The component appears to be same may have small differences which will cause malfunction if interchanged.
- In case of difficulty you should contact the Agent, Distributor or **ROTEX** directly.
- Using **ROTEX** genuine spares will **guarantee** you trouble free operation and will avoid premature failure.

(A) **TO REPLACE SOLENOID**

- 1) Open Nut & tubing and pull out solenoid.
- 2) Replace new solenoid ensuring the construction, voltage and current meets the requirements.
- 3) Tighten the Nut & tubing by applying torque of 0.2 kgm to 0.35 kgm to avoid over tightening of the solenoid.
- 4) Measure and record resistance of the Solenoid.

(B) **TO REPLACE GUIDE ASSEMBLY (CORE TUBE) / PLUNGER**

- 1) Open Nut & tubing and pull out solenoid.
- 2) Open Guide Assembly (Core Tube) using guide opening tool.
- 3) Remove Plunger Assembly.
- 4) Replace the necessary defective parts ensuring that the plunger assembly spring and the retaining ring.
- 5) The Plunger is interchangeable and can be fitted in the existing Guide Assembly (Core Tube).
- 6) Fix Guide Assembly (Core Tube) using correct tool.
- 7) Fix the solenoid and Dome Nut as per Point-3 of procedure A.
- 8) Even though it is not recommended, in case if required, the Guide Assembly (Core Tube) can be opened using plier or other similar tool ensuring that the same does not damage anything or component and the plier is tightening above weld joint (weld joint should be at the centre of plier jaw width).

(C) **REPLACEMENT OF MANUAL OVERRIDE**

- 1) Remove Grub Hex. Socket Set Screw and pull out Manual Override.
- 2) Replace new Manual Override applying light layer of Silicon Grease Molykot M55 and tighten the grub screw fully till the Manual Override stops traveling in and out.
- 3) Open the Grub Hex. Socket Set Screw slightly (1/4 turn) and check the smooth movement of the Grub Hex. Socket Set Screw.
-  4) Without connecting air supply to the valve, operate Manual Override. Energize and De-energize Solenoid to check for the plunger movement (normally movement should not be there) which can be checked by click sound. After operating Manual Override if plunger movement is found, reduce length of the manual override by 0.3mm from its taper end. Continue this till click sound stops.

(D) **REPLACEMENT OF O RINGS**

- 1) Remove solenoid if necessary as per Procedure (A).
- 2) Remove Deckel (Cover) by opening screws.
- 3) Remove Ventilfeder (Valve Spring).
- 4) Open Allen bolt.
- 5) Remove all the "O" Rings [Piston O Ring, Seat O Ring, and Body O Ring].
- 6) Clean components.
- 7) Fix new O Rings applying light layer of Molykot M55 grease.
- 8) Ensure that the O Rings and other rubber parts are compatible to the media passing through the valve.
- 9) Reassemble the valve.
- 10) Check operation and leakage of the valve
- 11) Contact ROTEX in case of any difficulty.

STORING, CLEANING AND MOUNTING OF ELASTOMERS: SYNTHETIC RUBBER PRODUCTS

- Store Plunger, O Ring Set in sealed polyethylene bag, kept in cool, dry, dust free area and avoid direct contact with all light sources emitting ultra violet rays, or contact with fumes, solvents, fuels, lubricants, chemicals, acids, disinfectants.
- Follow Maintenance General Instruction & specific procedures to replace O Ring set as listed above.



Guide Opening Tool M-32/22
Photo – 1

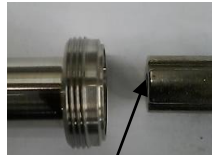

Flat Face this side
Photo – 2



Plunger with fixed conical &
cylindrical seal (Old Plunger)
Photo – 3



Plunger with moving seal
(New Design Plunger) –
Photo - 4

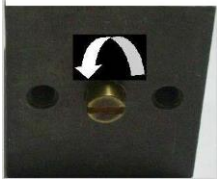

Manual Override "OFF"
Photo-5

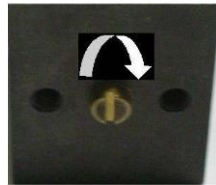

Manual Override "ON"
Photo – 6

Contact:

ROTEX AUTOMATION LIMITED

987/11, GIDC, MAKARPURA, VADODARA – 390010, INDIA

Tel.: +91 265 2638136, 2638746, 2638795 Fax: +91 265 2638130

E-mail: rotexbrd@rotexautomation.com Website: www.rotexautomation.com