

**MOUNTING, OPERATING, TESTING & MAINTENANCE INSTRUCTIONS
 FOR ROTEX 2/2 AIR OPERATED ISOLATED PISTION VALVE
 MODEL 23104**

ROTEX retains all rights to this publication.

All details within this manual and the catalogue are subject to change without manner.

ROTEX will not be responsible for any damage whatsoever arising from the use of the Solenoid Valve, due to misuse or incorrect installation or misinterpretation of the information contained herein.

SPECIFICATION OF AIR OPERATED VALVE

TYPE : 2 Port 2 Positions
 OPERATION : AIR OPERATED, ISOLATED PISTION POPPET TYPE VALVE
 ORIFICE = NW : 12 mm, 20 mm,
 OPERATING PRESSURE : 0-20 bar
 PILOT PRESSURE : Pilot pressure should be minimum 3 bar or \geq main fluid pressure.

CONSTRUCTION

Body	Aluminium Cast	(*)	CF8M	(B12)	CF8	(B13)		
Internal	Al., Br., SS		SS316		SS304			
Seals	NBR(*)	Viton (S2)	EPDM (S1)					
Springs	SS302							

IDENTIFICATION ON THE SOLENOID VALVE

a) VALVE LABEL

Label on the **ROTEX** Solenoid Valve shows the following details :

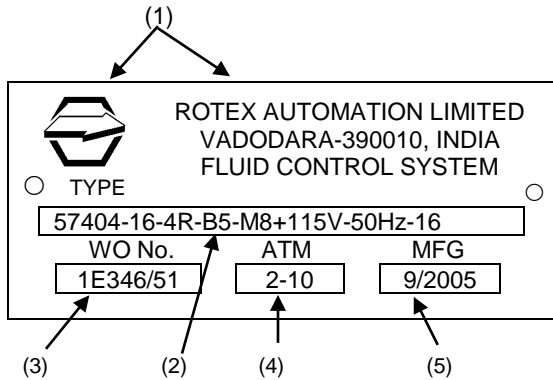

- (1) Logo + Name & address of the Manufacturer
- (2) Valve Type / Code
 - 57404 = Valve Model
 - Suffix = Nil
 - 16 = Orifice \varnothing
 - 4R = Port Connection (NPT)
 - B5 = Body Material (SS)
 - Nil = Seal Material (NBR)
 - M8 = Manual Override (Push)
 - 115 V = Solenoid Voltage
 - 50 Hz = Current (AC)
 - 16 = Enclosure : Terminal box
 - Nil = Solenoid Class 'F' Insulation
 - Sp. Version = Nil
- (3) Work Order reference / Sr. No. of the Valve
- (4) Operating Pressure
- (5) Month & Year of manufacture
- (6) Valve Symbol
- (7) Media
- (8) ATEX Ex mark for Valve (Non Electrical Part)
- (9) "CE" mark for ATEX and/or PED compliance.

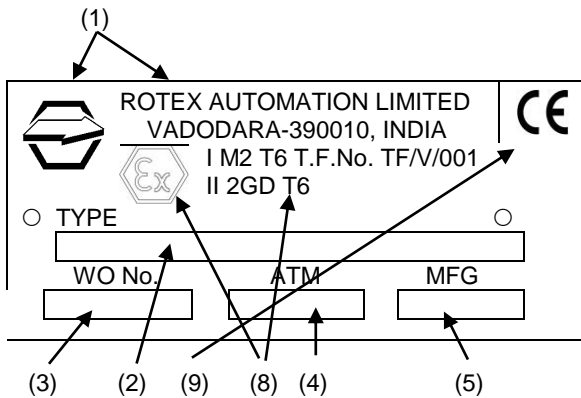
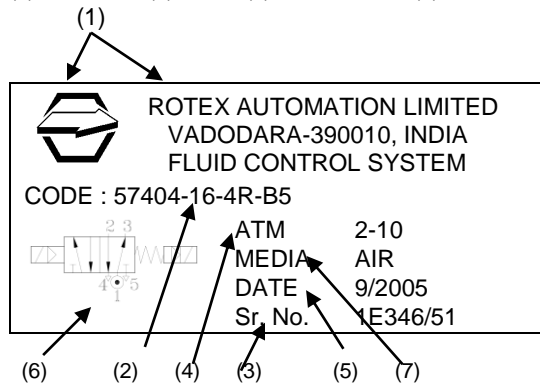

b) SOLENOID LABEL

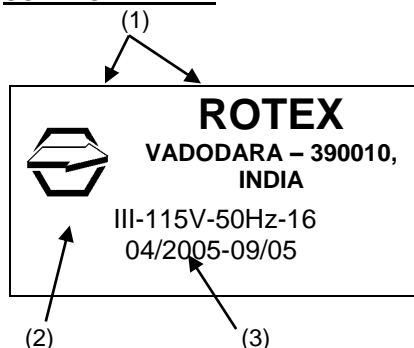

- (1) Logo + Name of the Manufacturer
- (2) Solenoid Type
 - III = Solenoid Size III
 - 115V = Solenoid Voltage
 - 50 Hz = Solenoid Current
 - 16 = Solenoid Construction (Plug In DIN)
 - Nil = Solenoid Class F Insulation
- (3) Plan No. & Manufacturing Month / Year

c) **PORT IDENTIFICATION**

A solenoid Valve with NPT (F) threading is normally marked “N” near the port and with Metric threads are marked “M”. For ports with BSP threads, there is no marking.

d) Voltage, current & other details are additionally marked/punched on the solenoid.

CONNECTION

VALVE TYPE	FUNCTION	IN	OUT	PILOT IN
23104	NC	2	1	7

(A) **OPERATING PRINCIPLE**

In de energized condition of the solenoid, when we applied the pressure from External Pilot Inlet (Port # 7) the media will pass through pilot hole up to above the kolben, so kolben assembly will get down and the Inlet (Port # 2) of the main valve will be disconnected from Outlet (Port # 1).

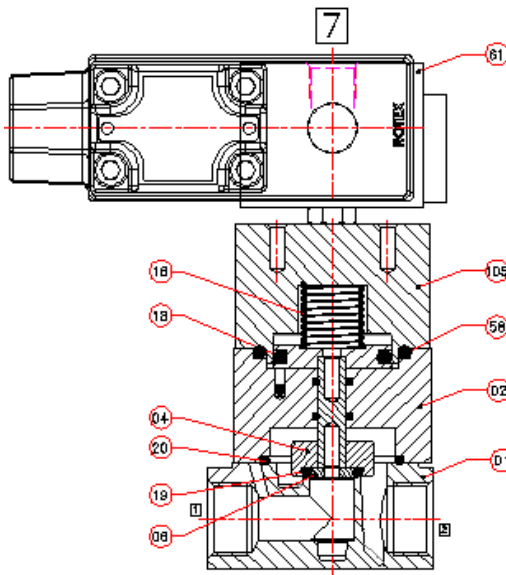

In energized condition of the solenoid, when we applied the pressure from External Pilot Inlet (Port # 7) the media will pass through pilot hole up to below the kolben, so kolben assembly will lift and the Inlet (Port # 2) of the main valve will be connected to Outlet (Port # 1).







01	TOP DECKEL	11	105	AL
01	PILOT VALVE	10	61	---
01	'O' RING	09	58	NBR/Viton/EPDM
01	BODY 'O' RING	08	20	NBR/Viton/EPDM
01	SEAT 'O' RING	07	19	NBR/Viton/EPDM
01	PISTON 'O' RING	06	18	NBR/Viton/EPDM
01	VENTILFEDER (VALVE SPRING)	05	16	SS
01	DRUCKSHEIBE	04	06	BRASS/SS316
01	KOLBEN (PISTON)	03	04	BRASS/SS316
01	MIDDEL DECKEL	02	02	AL/BRASS/SS316
01	GEHAUSE (BODY)	01	01	AL/BRASS/SS316
QTY.	DESCRIPTION	SR.No.	POS.No.	MATERIAL

(B) MOUNTING/INSTALLATION PROCEDURE :

1. ENSURE THAT:

- a) While storing, keep the valve in cool, dry, dust free area.
 - b) On receipt of the valve, in case if the same is to be removed from the sealed plastic bag for inspection/testing, put them back with dust plugs on its ports and sealing the plastic bag as soon as the inspection/testing is over.
 - c) The valve should be removed from its card board and/or plastic bag just before the installation.
 -  d) Flush lines before installing the valve.
 -  e) To avoid pressure drop and to achieve optimum parameters, Pipe / Tube / Fitting from the source of pressure to the valve and to the connected equipment should have ID which is \geq NW (Orifice) of the valve.
 - f) To avoid pressure drop, if more than one valve is being operated simultaneously from a common header, then minimum ID of the header can be calculated as under.
$$ID \text{ Header} = \sqrt{(NW^2 \times n)}$$

n = Number of Valves operating at a time and which are connected to a common header,
NW = Orifice of the Valve.
 -  g) Incorporate filter in the line to avoid hard particles entering into the valve.
 -  h) The valve should be installed for the media for which it is intended for. This is to avoid the malfunction of seals and the valve. In case if you intend to use valve for media other than the one specified on that valve, check compatibility of media to Body Seal material and grease. Consult **ROTEX** in case if any doubt.
 - i) Do not try to drill any additional holes or machine, modify any of the valve components.
 -  j) In case if the valve is used for dangerous fluid gas/liquid then, the user is hereby advised to maintain during operation and maintenance of the valve below LEL or above UEL to avoid explosion due to internal spark as the valves have not been assessed for the same.
 - k) Inlet pressure does not exceed rated pressure.
 - l) Hemp-Filaments, 'Jute' or even Teflon-Ribbons are normally not required, as the port connections of ROTEX Valve is accurately machined.
 - m) To avoid over lap of the Teflon ribbon or cuts generated while tightening, getting carried away into the valve. Do not cover first two thread pitches with Teflon tape or sealant.
2. The process fluid etc. : do not fall on the valve body.
3. In case if the surrounding atmosphere has traces or some other substance other than Air, check its compatibility with the Body material of the valve , Solenoid enclosure & other exposed parts.
-  4. It is not likely however, the user is advised to protect the valve against lightening as the same is not Assessed.
5. Check internal components (wetted) parts for its compatibility with fluid passing through the valve.
-  6. **It is recommended to replace all the Rubber Parts including Plunger Assembly (Repair Kit – Code 99) in case if the valve is to be installed and put in service after 2 years from the date of manufacture.**

TESTING OF THE VALVE AT THE TEST BENCH

-  Check at least once in 3 years or following your routine maintenance schedule.

- a) Apply rated pressure at inlet port of the valve.
- b) Check leakage at Port-2 of the valve in de-energized condition by applying soap solution.
- c) Check leakage at joints of the valve by applying soap solution.

RECOMMENDED SPARES

- a) Seal Kit (O Ring) (Code – 98).

SPARE ORDERING CODE

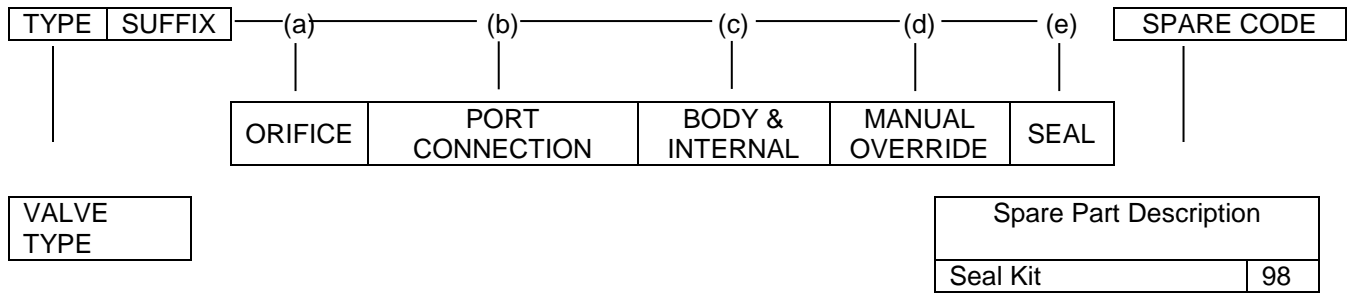

RECOMMENDED MAINTENANCE

- Replacement of Complete Set of O Ring Once in 5 years or 2 million operations.
 - Seat O Ring, Piston O Ring, Body O Ring

PREVENTIVE

MAINTENANCE – GENERAL INSTRUCTION

- ⚠ • It is recommended to replace complete set of O Ring even if one of the O Ring is damaged. This is to ensure trouble free operation of the valve and will avoid its premature failure.
- Using Grease other than Silicon base Molykote M55 will lead to premature failure of O Rings of the **ROTEX** Solenoid valve.
- ⚠ • If necessary to clean the components, **do not use Kerosene, Diesel, Petrol to clean valve as this damages the O Rings and other rubber material. Instead use light Detergent Soap Solution.**
- Ensure that the components are free from dust, dirt, lint and metal burrs.
- Twisting of O Ring should be avoided. Ensure that the twist is removed before fitting matching part.
- While closing the matching part, the matching part should be pushed in a straight line. Turning motion should be avoided.
- Pinching of O Ring at the groove corner at the time of closing gland should be avoided.
- User is requested to use safe practice for maintenance.
- It is important to place the dismantled Valve Parts on a clean paper or cloth in same sequence in which you have dismantled them.
- Ensure to keep all the components of the valve separately to avoid their mixing up. The component appears to be same may have small differences which will cause malfunction if interchanged.
- In case of difficulty you should contact the Agent, Distributor or **ROTEX** directly.
- Using **ROTEX** genuine spares will **Guarantee** you trouble free operation and will avoid premature failure.

(D) REPLACEMENT OF O RINGS

- 1) Remove Top Deckel by opening four screws.
- 2) Remove Ventilfeder (Valve Spring).
- 3) Remove Hex Socket Head Screw.
- 4) Remove the O Ring [Piston O Ring.
- 5) Remove the Middle Deckel.
- 6) Remove all the Seat O Ring, Body O Ring.
- 7) Clean components.
- 8) Fix new O Rings applying light layer of Molykot M55 grease.
- 9) Ensure that the O Rings and other rubber parts are compatible to the media passing through the valve.
- 10) Reassemble the valve.
- 11) Check operation and leakage of the valve.
- 12) Contact ROTEX in case of any difficulty.

Contact:

ROTEX AUTOMATION LIMITED
 987/11, GIDC, MAKARPURA, VADODARA – 390010, INDIA
 Tel. : +91 265 2638136, 2638746, 2638795 Fax : +91 265 2638130
 E-mail : rotexbrd@rotexindia.com Website : www.rotexindia.com