

**MOUNTING, OPERATING, TESTING & MAINTENANCE INSTRUCTIONS
 FOR ROTEX 2/2 INTERNAL PILOT, DIAPHRAGM OPERATED,
 INLINE, NORMALLY CLOSED SOLENOID VALVE
 MODEL: 24101, 24102, 24103, 24109, 24101V01, 24102V01, 24129, 24132**

ROTEX retains all rights to this publication.

All details within this manual and the catalogue are subject to change without manner.

ROTEX will not be responsible for any damage whatsoever arising from the use of the Solenoid Valve, due to misuse or incorrect installation or misinterpretation of the information contained herein.

VALVE TYPE	FUNCTION	IN	OUT
24101, 24102, 24103, 24109, 24101V01, 24102V01, 24129, 24132	Normally Close	2	1

(A) OPERATING PRINCIPLE

In de-energized condition of the solenoid, applied the pressure at inlet port # 2, a part of media drawn from surrounding hole of the duse to top face of plunger assembly and this media pressure support to spring to keep plunger assembly downwards and keep the duse hole blocked. Remaining pressure passed from pilot hole of the diaphragm and act on the diaphragm assembly, thus diaphragm assembly keep down wards. In this state, Inlet port # 2 and Outlet port #1 are disconnected. Media cannot come out from outlet port.

In energized condition of the solenoid plunger assembly moves upwards and open the duse hole, media exhaust from the outlet port # 1. now applied the pressure at Inlet port 2, media pressure act below the diaphragm assembly so, it moves up wards. in this state, Inlet port # 2 and outlet port #1 are connected. Media pressure come out from outlet port # 1.

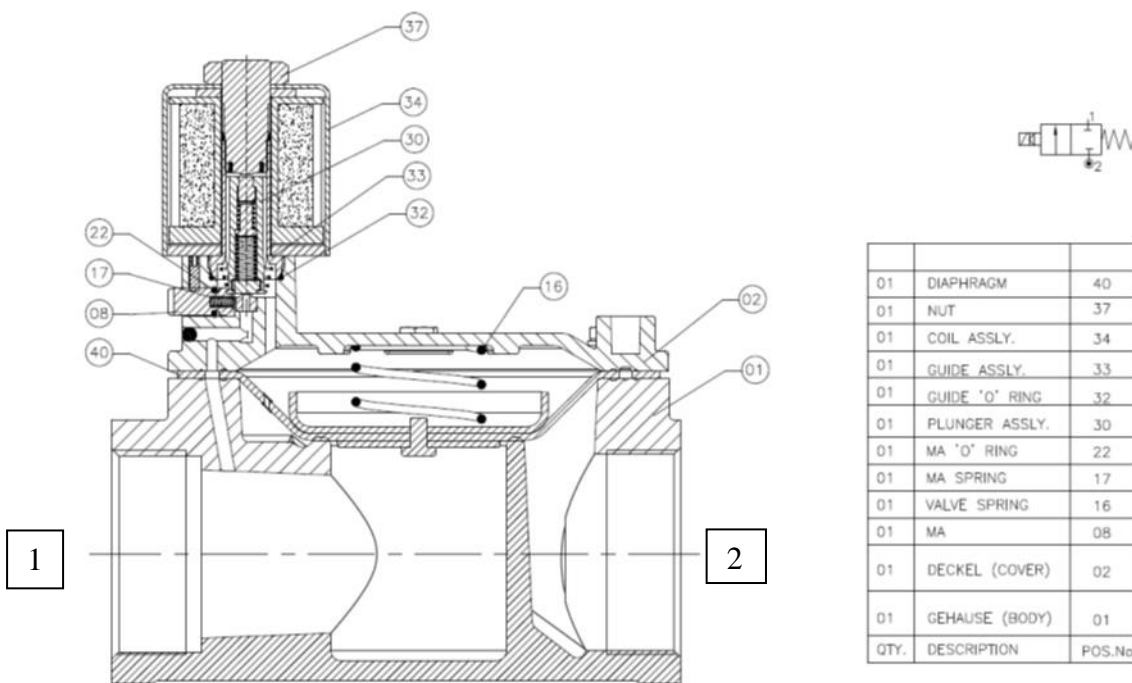

IDENTIFICATION ON THE SOLENOID VALVE

a) VALVE MARKING

Label on the **ROTEX** Solenoid Valve shows the following details:

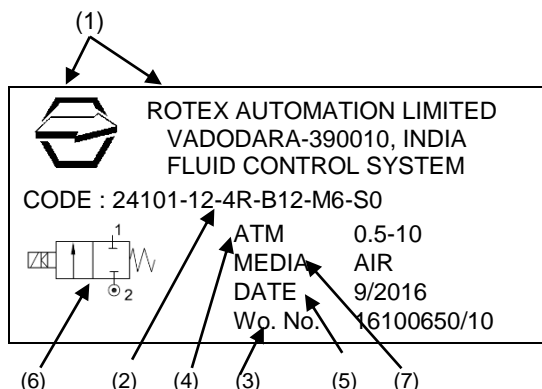

- (1) Logo + Name & address of the Manufacturer
- (2) Valve Type / Code
 24101 = Valve Model
 Suffix = Nil
 12 = Orifice Ø
 4R = Port Connection
 B12 = Body Material
 M6 = Manual Override
 S0 = Seal Material
- (3) Work Order reference / Sr. No. of the Valve
- (4) Operating Pressure
- (5) Month & Year of manufacture
- (6) Valve Symbol
- (7) Media

b) SOLENOID MARKING

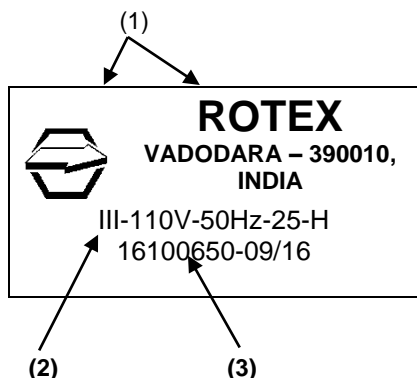

- (1) Logo + Name of the Manufacturer
- (2) Solenoid Type
 III = Solenoid Size I
 110V = Solenoid Voltage
 50 Hz = Current Frequency
 25 = Solenoid Construction
 H = Solenoid Insulation Class H
- (3) Work order No. Manufacturing Month / Year

c) PORT IDENTIFICATION

A solenoid Valve with NPT (F) threading is normally marked “N” near the port and with Metric threads are marked “M”. For ports with BSP threads, there is no marking.

d) Voltage, current & other details are additionally marked/ punched on the solenoid.

NOTE: The product without marking is out of warranty and risk.

(B) MOUNTING/INSTALLATION PROCEDURE:

1. ENSURE THAT:

- a) While storing, keep the valve in cool, dry, dust free area.
- b) On receipt of the valve, in case if the same is to be removed from the sealed plastic bag for inspection/testing, put them back with dust plugs on its ports and sealing the plastic bag as soon as the inspection/testing is over.
- c) The valve should be removed from its card board and/or plastic bag just before the installation.
- d)** Flush lines before installing the valve.
- e)** To avoid pressure drop and to achieve optimum parameters, Pipe / Tube / Fitting from the source of pressure to the valve and to the connected equipment should have ID which is ≥ NW (Orifice) of the valve.
- f)** To avoid pressure drop, if more than one valve is being operated simultaneously from a common header, then minimum ID of the header can be calculated as under.

$$ID\ Header = \sqrt{(NW^2 \times n)}$$
 n = Number of Valves operating at a time and which are connected to a common header,
 NW = Orifice of the Valve.
- g)** Incorporate filter in the line to avoid hard particles entering into the valve.
- h)** The valve should be installed for the media for which it is intended for. This is to avoid the malfunction of seals and the valve. In case if you intend to use valve for media other than the one specified on that valve, check compatibility of media to Body Seal material and grease. Consult **ROTEX** in case if any doubt.
- i)** Do not try to drill any additional holes or machine, modify any of the valve components.
- j)** In case if the valve is used for dangerous fluid gas/liquid then, the user is hereby advised to maintain during operation and maintenance of the valve below LEL or above UEL to avoid explosion due to internal spark as the valves have not been assessed for the same.
- k)** Inlet pressure does not exceed rated pressure.

- l) Hemp-Filaments, 'Jute' or even Teflon-Ribbons are normally not required, as the port connections of ROTEX Valve is accurately machined.
- m) To avoid overlap of the Teflon ribbon or cuts generated while tightening, getting carried away into the valve. Do not cover first two thread pitches with Teflon tape or sealant.
- ⚠** n) **For Solenoid Valve to be installed in European Union, check the applicability for ATEX. Refer separate Instruction Manual for ATEX approved Solenoid Valve.**

- 2. The process fluid etc.: do not fall on the valve body.
- 3. In case if the surrounding atmosphere has traces or some other substance other than Air, check its compatibility with the Body material of the valve, Solenoid enclosure & other exposed parts.
- ⚠** 4. In case if the valve is installed in potentially Hazardous area, check for the temperature class of the Solenoid to avoid explosion due to heated Solenoid / other components.
- ⚠** 5. Provide fuse of proper rating to avoid excess current passing through the Solenoid and thereby avoiding overheating.
- ⚠** 6. It is not likely however the user is advised to protect the valve against lightening as the same is not assessed.
- 7. Check internal components (wetted) parts for its compatibility with fluid passing through the valve.
- ⚠** 8. **It is recommended to replace all the Rubber Parts including Plunger Assembly in case if the valve is to be installed and put in service after 2 years from the date of manufacture.**

ELECTRICAL

- 1. Verify Laser marking on the Solenoid.
- 2. Connect the power supply according to the voltage rating of the Solenoid.
- 3. Ensure that the cover of Junction Box/Terminal Box is properly tightened wherever applicable.
- ⚠** 4. Install valve in such a way that the rain water / other process fluid dripping along the cable does not fall on the SOV and has no possibility to run along the cable and enter into the Terminal area.
- 5. Fill in the space between cable and gland entry with a proper sealant. If necessary, you may mount the valve upside down or in any other direction.
- 6. Ensure that the Solenoid enclosure meets process and local authority requirement.
- 7. The Plug In, Terminal Box, FPJB, IS Solenoids are provided with test leads. Remove them before final installation.
- ⚠** 8. Check for proper connections for the Solenoid which are polarity sensitive e.g. (a) Latched Solenoid (b) Ex ia Solenoid.
- 9. Ensure that the solenoid construction is selected properly meeting the environment in which the valve is supposed to be installed e.g. use of Exd or Ex ia solenoid for valve to be installed in hazardous location or Weatherproof Solenoid having IP 67 for outdoor installation.
- 10. Refer separate manual for construction of the Solenoid and for specific instructions related to Solenoid e.g. (a) Ex ia (b) Latched Solenoid (c) Ex d Solenoid IP 67.

TESTING OF THE VALVE AT THE TEST BENCH

- ⚠** Check at least once in 3 years or follow your routine maintenance schedule.
- a) Apply rated pressure at inlet port of the valve. Check for leakage at mounting bolt, body & deckel joint.
- b) Energize the valve and again de-energize. Again, check for leakage at mounting bolt, body & deckel joint.
- c) Plug outlet port.
- d) Check operation of the valve and leakage at the joints and pilot vent at the rated and minimum working pressure by applying 75% to 120% rated voltage.
- e) Check the insulation resistance of the Solenoid by applying 500V DC at terminals and the solenoid housing. It should be more than 100 Mega Ohms.
- f) Without connecting air supply to the valve, operate Manual Override. Energize and De-energize Solenoid to check for the plunger movement (normally movement should not be there) which can be checked by click sound. After operating Manual Override if plunger movement is found, reduce length of the manual override by 0.3mm from its taper end. Continue this till click sound stops.

RECOMMENDED SPARES

- a) Seal Kit (O ring set + Diaphragm kit + Plunger Assembly) [Code:98]
98-Valve Model
- b) Diaphragm Assembly (Diaphragm kit & Valve spring) [Code:100]
100-Valve model
- c) Spare Solenoid (Solenoid, Gasket & Nut) [Code:34]
34-Solenoid Model
- d) Repair Kit (All component except Body, Cover and Solenoid) [Code:99]
99-Valve model

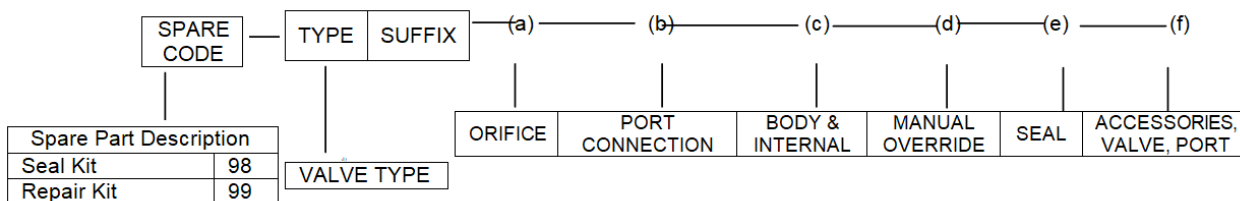



RECOMMENDED MAINTENANCE

- Replacement of Complete Set of O Ring
 - Guide O Ring, Diaphragm assembly
- Replacement of Plunger Assembly
- Replacement of the Solenoid
- Check of Insulation Resistance, Resistance of the Solenoid...
- Check Resistance of the Solenoid... ..

PREVENTIVE

- Once in 5 years or 2 million operations.
- Once in 5 years or 2 million operations
 As and when required.
- Once in a year (should be ≥ 100 MOhms @
 500V DC.
- Replace Solenoid if the resistance reduces
 more than 5% computed at 20°C as compared
 to its Initial value.

MAINTENANCE – GENERAL INSTRUCTION

- The Solenoid Valve must be removed from the site and has to be maintained under safe conditions.
-  • All air and electrical connections must be switched off before removing valve from the line.
-  • It is recommended to replace complete set of O Ring even if one of the O Ring is damaged. This is to ensure trouble free operation of the valve and will avoid its premature failure.
- Using Grease other than Silicon base Molykote M55 will lead to premature failure of O Rings of the **ROTEX** Solenoid valve.
-  • If necessary to clean the components, **do not use Kerosene, Diesel, Petrol to clean valve as this damages the O Rings and other rubber material. Instead use light Detergent Soap Solution.**
- Ensure that the components are free from dust, dirt, lint and metal burrs.
- Twisting of O Ring should be avoided. Ensure that the twist is removed before fitting matching part.
- While closing the matching part, the matching part should be pushed in a straight line. Turning motion should be avoided.
- Pinching of O Ring at the groove corner at the time of closing gland should be avoided.
- User is requested to use safe practice for maintenance.
- It is important to place the dismantled Valve Parts on a clean paper or cloth in same sequence in which you have dismantled them.
- Ensure to keep all the components of the valve separately to avoid their mixing up. The component appears to be same may have small differences which will cause malfunction if interchanged.
- In case of difficulty you should contact the Agent, Distributor or **ROTEX** directly.
- Using **ROTEX** genuine spares will **Guarantee** you trouble free operation and will avoid premature failure.

(A) **TO REPLACE SOLENOID**

- 1) Open nut and pull out solenoid
- 2) Replace new solenoid ensuring the construction, voltage and current meets the requirements.
- 3) Tighten the nut applying torque of 0.2 kgm to 0.35 kgm to avoid over tightening of the solenoid.
- 4) Measure and record resistance of the Solenoid.

B) **TO REPLACE GUIDE ASSEMBLY (CORE TUBE) / PLUNGER**

- 1) Open nut and pull out solenoid.
- 2) Open Guide Assembly (Core Tube) using spanner.
- 3) Remove Plunger Assembly.
- 4) Replace the necessary defective parts ensuring that the plunger assembly spring and the retaining ring.
- 5) The Plunger is interchangeable and can be fitted in the existing Guide Assembly (Core Tube).
- 6) Fix Guide Assembly (Core Tube) using correct tool.
- 7) Fix the solenoid and nut as per Point-3 of procedure A.
- 8) Even though it is not recommended, in case if required, the Guide Assembly (Core Tube) can be opened using plier or other similar tool ensuring that the same does not damage anything or component and the plier is tightening above weld joint (weld joint should be at the center of plier jaw width).

(C) **REPLACEMENT OF O RINGS**

- 1) Remove solenoid if necessary as per Procedure (A).
- 2) Remove Guide using appropriate tools.
- 3) Replace the Guide O Ring.
- 4) Clean components.
- 5) Fix new O Rings applying light layer of Molykote M55 grease.
- 6) Ensure that the O Rings and other rubber parts are compatible to the media passing through the valve.
- 7) Reassemble the valve.
- 8) Check operation and leakage of the valve.
- 9) Contact ROTEX in case of any difficulty.

(D) **REPLACEMENT OF DIAPHRAGM**

- 1) Remove cover by opening Bolts.
- 2) Replace new Diaphragm / Diaphragm Assembly ensuring that the seat (solid portion) is facing downward towards the body and the ribs are facing Diaphragm Assembly cover.
- 3) Fix Body & cover with bolt matching shape.

STORING, CLEANING AND MOUNTING OF ELASTOMERS: SYNTHETIC RUBBER PRODUCTS

- Store Plunger, O Ring Set in sealed polyethylene bag, kept in cool, dry, dust free area and avoid direct contact with all light sources emitting ultra violet rays, or contact with fumes, solvents, fuels, lubricants, chemicals, acids, disinfectants.
- Follow Maintenance General Instruction & specific procedures to replace O Ring set as listed above.



Guide Opening Tool M-32/22
Photo – 1



Flat Face this side
Photo – 2



Plunger with fixed conical &
cylindrical seal (Old Plunger)
Photo – 3



Plunger with moving seal
(New Design Plunger) - Photo – 4

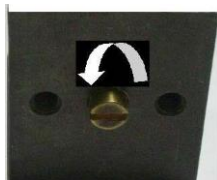

Manual Override "OFF"
Photo-5

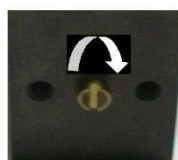

Manual Override "ON"
Photo – 6

Contact:

ROTEX AUTOMATION LIMITED

987/11, GIDC, MAKARPURA, VADODARA – 390010, INDIA

Tel.: +91 265 2638136, 2638746, 2638795 Fax : +91 265 2638130

E-mail: rotexbrd@rotexautomation.com Website: www.rotexautomation.com