

## MOUNTING, OPERATING, TESTING & MAINTENANCE INSTRUCTIONS FOR ROTEX 3/2 DIRECT ACTING HIGH ORIFICE SOLENOID VALVE MODEL 30308, 30334, 30333, 30309, 30329

ROTEX retains all rights to this publication.

All details within this manual and the catalogue are subject to change without manner.

ROTEX will not be responsible for any damage whatsoever arising from the use of the Solenoid Valve, due to misuse or incorrect installation or misinterpretation of the information contained herein.

VALVE MODEL-ORIFICE	FUNCTION	IN	OUT	EXHAUST
30308-5   30334-5   30333-5   30334-7	NC	1	2	3
30309-10   30329-5   30329-7	NO	3	2	1
30329-10	Mixing	1,3	2	-
	Diverting	2	1,3	-

### (A) OPERATING PRINCIPLE

#### NC Operation

In de-energized condition of the solenoid, applied the pressure at inlet port # 1, media passed up to the duse hole which is blocked by plunger assembly. In this state inlet port # 1 and outlet port # 2 are disconnected. Outlet port # 2 and exhaust port # 3 are connected. Media cannot come out from the outlet port # 2.

In energized condition of the solenoid, plunger assembly moves up now when we applied the pressure at inlet port # 1 media pressure come out from the outlet port # 2 through the duse hole. In this state inlet port #1 & outlet port # 2 is connected and exhaust port # 3 is blocked. So media comes from the outlet port # 2

#### NO Operation

In de-energized condition of the solenoid, applied the pressure at inlet port # 3. In this state inlet port # 3 and outlet port # 2 are connected. Outlet port # 2 and exhaust port # 1 are disconnected. Media come out from the outlet port # 2.

In energized condition of the solenoid, plunger assembly moves up now when we applied the pressure at inlet port # 3. In this state inlet port # 3 & outlet port # 2 disconnected and outlet port # 2 and exhaust port # 1 are connected. So media cannot come out from the outlet port # 2.

#### MIXING OPERATION

Inlet at Port 1 and Port 3 are alternately connected to port 2 when the solenoid is energized / de-energized.

#### DIVERTING OPERATION

Inlet at Port 2 is alternately connected to Port 1 or Port 3 when solenoid is energized / de-energized.

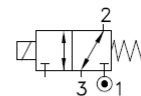
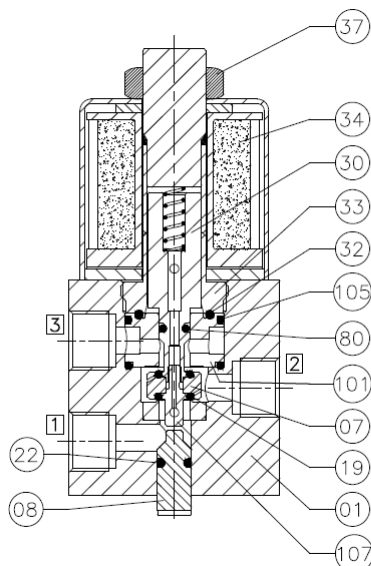

01	M HOLDER	107
02	SLEEVE 'O' RING	105
01	SLEEVE	101
01	PLUNGER 'O' RING	80
01	NUT	37
01	COIL ASSLY.	34
01	GUIDE ASSLY.	33
01	GUIDE 'O' RING	32
01	PLUNGER ASSLY.	30
01	MA 'O' RING	22
02	SEAT 'O' RING	19
01	MA	08
01	PRESSURE PLATE(VENTILTELLER)	07
01	BODY (GEHAUSE)	01
QTY.	DESCRIPTION	POS.No.

**VALVE MODEL 30308, 30334**

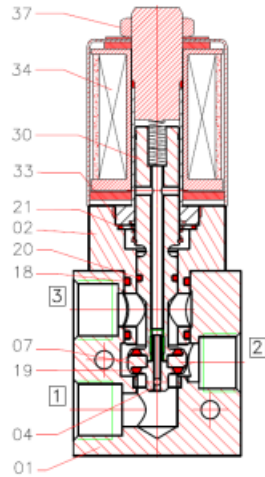

01	NUT	37
01	COIL	34
01	GUIDE ASSLY.	33
01	PLUNGER ASSLY.	30
01	GUIDE 'O' RING	21
02	ANKER 'O' RING	20
02	SEAT 'O' RING	19
01	BODY 'O' RING	18
01	VENTILTELLER (PRESSURE PLATE)	07
01	MHOLDER	04
01	DECKEL (COVER)	02
01	GEHAUSE (BODY)	01
QTY.	DESCRIPTION	POS.No.

**VALVE MODEL 30309, 30329**

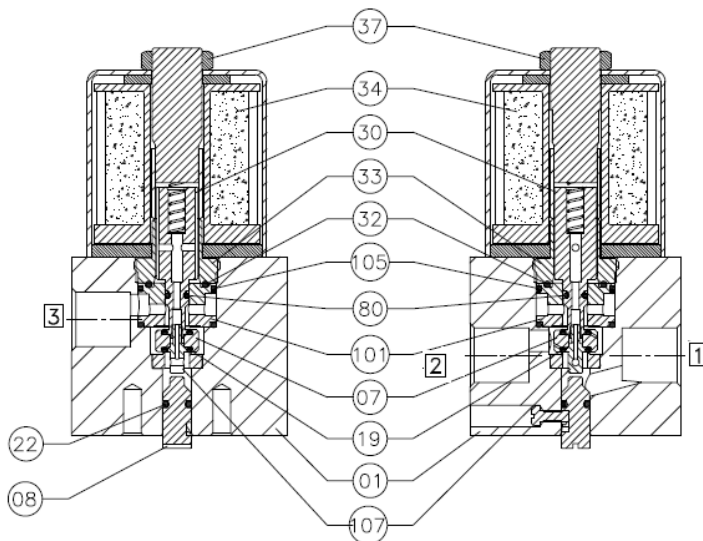

01	M HOLDER	14	107
02	SLEEVE 'O' RING	13	105
01	SLEEVE	12	101
01	PLUNGER 'O' RING	11	80
01	NUT	10	37
01	COIL ASSLY.	09	34
01	GUIDE ASSLY.	08	33
01	GUIDE 'O' RING	07	32
01	PLUNGER ASSLY.	06	30
01	MA 'O' RING	05	22
02	SEAT 'O' RING	04	19
01	MA	03	08
01	PRESSURE PLATE(VENTILTELLER)	02	07
01	BODY (GEHAUSE)	01	01
QTY.	DESCRIPTION	Sr.No.	POS.No.

**VALVE MODEL 30333**

**IDENTIFICATION ON THE SOLENOID VALVE**

**a) VALVE MARKING**

Marking on the **ROTEX** Solenoid Valve shows the following details:

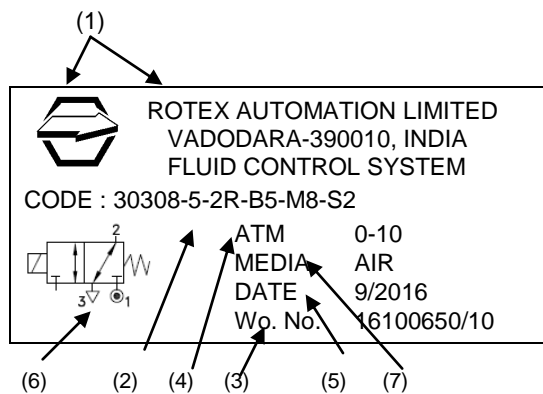

- (1) Logo + Name & address of the Manufacturer
- (2) Valve Type / Code  
 30308 = Valve Model  
 Suffix = Nil  
 5 = Orifice Ø (mm)  
 2R = Port Connection 1/4" NPT(F)  
 B5 = Body Material : SS316  
 M8 = Manual Override: Push type  
 S2 = Seal Material : Viton  
 Sp. Version = Nil
- (3) Work Order reference / Sr. No. of the Valve
- (4) Operating Pressure
- (5) Month & Year of manufacture
- (6) Valve Symbol
- (7) Media

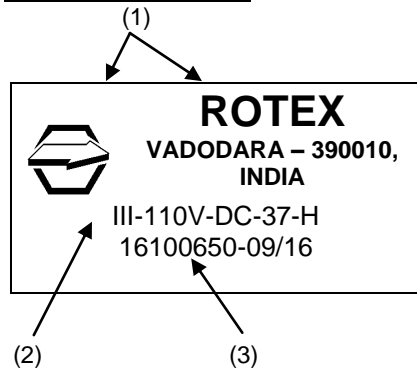
b) **SOLENOID MARKING**

- (1) Logo + Name of the Manufacturer  
 (2) Solenoid Type  
 III = Solenoid Size III  
 110V = Solenoid Voltage  
 DC = Voltage type DC  
 37 = Solenoid Construction  
 H = Solenoid Insulation Class H  
 (3) Work order No. Manufacturing Month / Year

c) **PORT IDENTIFICATION**

A solenoid Valve with NPT (F) threading is normally marked "N" near the port and with Metric threads are marked "M". For ports with BSP threads, there is no marking.



d) Voltage, current & other details are additionally laser marked on Solenoid.



**NOTE: The product without marking is out of warranty and risk**









**B) MOUNTING/INSTALLATION PROCEDURE:**

## 1. ENSURE THAT:

- a) While storing, keep the valve in cool, dry, dust free area.  
 b) On receipt of the valve, in case if the same is to be removed from the sealed plastic bag for inspection/testing, put them back with dust plugs on its ports and sealing the plastic bag as soon as the inspection/testing is over.  
 c) The valve should be removed from its card board and/or plastic bag just before the installation.  
 d) Flush lines before installing the valve.  
 e) To avoid pressure, drop and to achieve optimum parameters, Pipe / Tube / Fitting from the source of pressure to the valve and to the connected equipment should have ID which is  $\geq$  NW (Orifice) of the valve.  
 f) To avoid pressure, drop, if more than one valve is being operated simultaneously from a common header, then minimum ID of the header can be calculated as under.  

$$\text{ID Header} = \sqrt{(\text{NW}^2 \times n)}$$





$$n = \text{Number of Valves operating at a time and which are connected to a common header,}$$

$$\text{NW} = \text{Orifice of the Valve.}$$
  
 g) Incorporate filter in the line to avoid hard particles entering the valve.  
 h) The valve should be installed for the media for which it is intended for. This is to avoid the malfunction of seals and the valve. In case if you intend to use valve for media other than the one specified on that valve, check compatibility of media to Body Seal material and grease. Consult **ROTEX** in case if any doubt.  
 i) Do not try to drill any additional holes or machine, modify any of the valve components.  
 j) In case if the valve is used for dangerous fluid gas/liquid then, the user is hereby advised to maintain during operation and maintenance of the valve below LEL or above UEL to avoid explosion due to internal spark as the valves have not been assessed for the same.  
 k) Inlet pressure does not exceed rated pressure.  
 l) Hemp-Filaments, 'Jute' or even Teflon-Ribbons are normally not required, as the port connections of ROTEX Valve is accurately machined.  
 m) To avoid over lap of the Teflon ribbon or cuts generated while tightening, getting carried away into the valve. Do not cover first two thread pitches with Teflon tape or sealant.  
 n) **For Solenoid Valve to be installed in European Union, check the applicability for ATEX, PED. Refer separate Instruction Manual for ATEX approved Solenoid Valve.**
-  2. Provide Dust Cap on the exhaust port or ensure that the valve is mounted such a way that dust particles / rain water / process fluid do not enter the valve through exhaust port of the valve. You can connect bend pipe of ID  $\geq$  NW of the valve so that the exhaust port is not directly (straight) open into the atmosphere.
3. The process fluid etc.: do not fall on the valve body.
4. In case if the surrounding atmosphere has traces or some other substance other than Air, check its compatibility with the Body material of the valve, Solenoid enclosure & other exposed parts.
-  5. In case if the valve is installed in potentially Hazardous area, check for the temperature class of the Solenoid to avoid explosion due to heated Solenoid / other components.
-  6. Provide fuse of proper rating to avoid excess current passing through the Solenoid and thereby avoiding over heating.
-  7. It is not likely however; the user is advised to protect the valve against lightening as the same is not assessed.
8. Check internal components (wetted) parts for its compatibility with fluid passing through the valve.
-  9. **It is recommended to replace all the Rubber Parts including Plunger Assembly in case if the valve is to be installed and put in service after 2 years from the date of manufacture.**

**REMARKS**

- 1) Solenoid Valve in which media passing through the valve is **Gaseous** and Orifice less than 25mm, PED is not applicable.
- 2) Solenoid Valve in which media passing through the valve is **Liquid Hazardous** nature, pressure 0.5 bar and **Liquid Non-Hazardous** nature, pressure below 10 bar, PEF is not applicable.

**ELECTRICAL**

1. Verify name plate affixed on the Solenoid.
2. **For AC Voltage (50Hz or 60Hz), select solenoid with option "FR"**.
3. Connect the power supply as per the voltage rating of the Solenoid.
4. Ensure that the cover of Junction Box/Terminal Box is properly tightened wherever applicable.
-  5. Install valve in such a way that the rain water / other process fluid dripping along the cable does not fall on the SOV and has no possibility to run along the cable and enter into the Terminal area.
6. Fill in the space between cable and gland entry with a proper sealant. If necessary, you may mount the valve upside down or in any other direction.
7. Ensure that the Solenoid enclosure meets process and local authority requirement.
8. The Plug In, Terminal Box, FPJB are provided with test leads. Remove them before final installation.
-  9. Check for proper connections for the Solenoid which are polarity sensitive e.g. (a) Latched Solenoid.
-  10. **Refer separate manual for construction of the Solenoid and for specific instructions related to Solenoid e.g. (a) Latched Solenoid (b) Exd Solenoid IP 67**
11. Ensure that the solenoid construction is selected properly meeting the environment in which the valve is supposed to be installed e.g. use of Ex d solenoid for valve to be installed in hazardous location or Weatherproof Solenoid having IP 67 for outdoor installation.
-  12. **Flying Lead Solenoid is not recommended to be used for outdoor or indoor application where water/liquid splashing or high humidity is present.**
-  13. **Intrinsically Safe Solenoid can not be supplied with the Valve (Except 30308-5, 30334-5, 30333-5)**



**MANUAL OVERRIDE OPERATION – OPTIONALLY PROVIDED****(A) PUSH & TURN TYPE (M6)**

When the solenoid is de-energized and inlet and outlet ports connected to the applying rated pressure, the valve can be operated either pressing the Manual Override, when the same is released, the valve returns to the normal position. The valve can also be locked in energized position by pushing the Manual Override and rotating clockwise. To avoid Manual Override returning to normal condition, ensure that the same is turned above 90°. The valve can be brought to normal condition by turning Manual Override anti clockwise.

**(B) PUSH TYPE (M8)**

When the solenoid is de-energized, inlet and outlet ports connection and rated pressure applied, the valve can be brought to energized position by pressing Manual Override / Lever. The valve remains in this position till Manual Override / Lever is pressed. As soon as the same is released, the valve returns to the normal position.

**TESTING OF THE VALVE AT THE TEST BENCH**

-  Check at least once in 3 years or following your routine maintenance schedule.
- a) Apply rated pressure at inlet port of the valve.
- b) Plug outlet port.
- c) Check operation of the valve and leakage at the exhaust port at the rated and minimum working pressure by applying 75% to 120% rated voltage.
- d) While keeping the solenoid de-energized, check operation and leakage from exhaust of the valve at the rated and minimum working pressure by operating Manual Override.
-  e) Without connecting air supply to the valve, operate Manual Override. Energize and De-energize Solenoid to check for the plunger movement (normally movement should not be there) which can be checked by click sound. After operating Manual Override if plunger movement is found, reduce length of the manual override by 0.3mm from its taper end. Continue this till click sound stops.
- f) Check the insulation resistance of the Solenoid by applying 500V DC at terminals and the solenoid housing. It should be more than 100 Mega Ohms.

**RECOMMENDED SPARES :**

Code	Description	Components
98	Seal kit	O ring + Plunger Assembly
99	Repair kit	All components except Body, Cover and Solenoid
34	Solenoid kit	Solenoid, Gasket & Nut

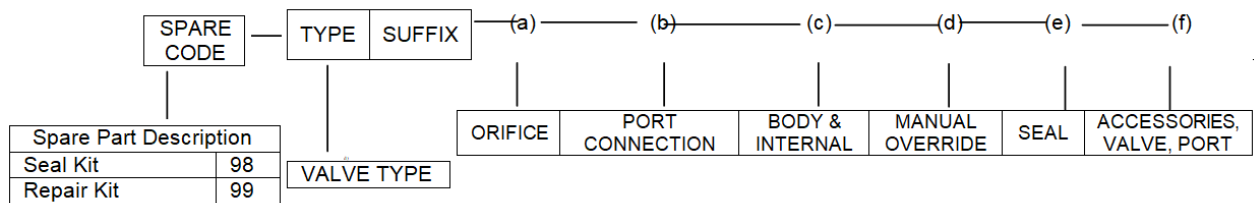
**SPARE ORDERING CODE****RECOMMENDED MAINTENANCE**

- |   |   |     |     |  |
|---|---|-----|-----|--|
| • | Replacement of Complete Set of O Ring                         | ... | ... | Once in 5 years or 2 million operations.   |
|   | - Guide O Ring, MA O Ring,                                    |     |     |  |
|   | - Body O Ring, Seat O Ring,                                   |     |     |  |
|   | - Plunger O ring, Sleeve O ring                               |     |     |  |
| • | Replacement of Plunger Assembly                               | ... | ... | Once in 5 years or 2 million operations  |
| • | Replacement of the Solenoid                                   | ... | ... | As and when required.  |
| • | Check of Insulation Resistance, Resistance of the Solenoid... | ... | ... | Once in a year (should be $\geq 100M$ Ohms @ 500V DC.  |
| • | Check Resistance of the Solenoid...                           | ... | ... | Replace Solenoid if the resistance reduces more than 5% computed at 20°C as compared to its Initial value. |

**PREVENTIVE****MAINTENANCE – GENERAL INSTRUCTION**

- The Solenoid Valve must be removed from the site and has to be maintained under safe conditions.
- ⚠ All air and electrical connections must be switched off before removing valve from the line.
- ⚠ It is recommended to replace complete set of O Ring even if one of the O Ring is damaged. This is to ensure trouble free operation of the valve and will avoid its premature failure.
- Using Grease other than Silicon base Molykote M55 will lead to premature failure of O Rings of the **ROTEX** Solenoid valve.
- ⚠ If necessary to clean the components, **do not use Kerosene, Diesel, Petrol to clean valve as this damages the O Rings and other rubber material. Instead use light Detergent Soap Solution.**
- Ensure that the components are free from dust, dirt, lint and metal burrs.
- Twisting of O Ring should be avoided. Ensure that the twist is removed before fitting matching part.
- While closing the matching part, the matching part should be pushed in a straight line. Turning motion should be avoided.
- Pinching of O Ring at the groove corner at the time of closing gland should be avoided.
- User is requested to use safe practice for maintenance.
- It is important to place the dismantled Valve Parts on a clean paper or cloth in same sequence in which you have dismantled them.
- Ensure to keep all the components of the valve separately to avoid their mixing up. The component appears to be same may have small differences which will cause malfunction if interchanged.
- In case of difficulty you should contact the Agent, Distributor or **ROTEX** directly.
- Using **ROTEX** genuine spares will **Guarantee** you trouble free operation and will avoid premature failure.

**(A) TO REPLACE SOLENOID**

- 1) Open dome nut and pull out solenoid.
- 2) Replace new solenoid ensuring the construction, voltage and current meets the requirements.
- 3) Tighten the dome nut applying torque of 0.2 kgm to 0.35 kgm to avoid over tightening of the solenoid.
- 4) Measure and record resistance of the Solenoid.

**(B) TO REPLACE GUIDE ASSEMBLY (CORE TUBE) / PLUNGER, SET OF 'O' RING**

- 1) Open dome nut and pull out solenoid.
- 2) Open Guide Assembly (Core Tube) using guide opening tool / spanner.
- 3) Pull out Plunger Assembly along with Sleeve.
- 4) Insert a small pin in the hole of magnet holder and second pin in the Plunger.
- 5) Open the same by rotating anti clockwise. Remove old 'O' Rings and clean metallic parts.
- 6) Replace all the 'O' Rings like Plunger O Ring, Seat O Ring and reassemble magnet holder into the Plunger using small amount of Loctite 242 on the thread of magnet holder.
- 7) Reassemble Sleeve along with Sleeve O Ring and insert assembly in the body.
- 8) Fix the Guide Assembly ensuring that Guide O Ring and Sleeve O Ring are well placed.
- 9) Check the valve for operation and leakage.

**(C) REPLACEMENT OF MANUAL OVERRIDE – OPTIONALLY PROVIDED**

- 1) Remove Grub Hex Socket Set Screw and pull out Manual Override.
- 2) Replace new Manual Override applying light layer of Silicon Grease Molykot M55 and tighten the grub screw fully till the Manual Override stops traveling in and out.
- 3) Open the Grub Hex Socket Set Screw slightly (1/4 turn) and check the smooth movement of the grub screw.
- ⚠ 4) Without connecting air supply to the valve, operate Manual Override. energized and De-Energized Solenoid to check for the plunger movement (normally movement should not be there) which can be checked by click sound.  
After operating Manual Override if plunger movement is found, reduce length of the manual override by 0.3mm from its taper end. Continue this till click sound stops.

**STORING, CLEANING AND MOUNTING OF ELASTOMERS: SYNTHETIC RUBBER PRODUCTS**

- Store Plunger, O Ring Set in sealed polyethylene bag, kept in cool, dry, dust free area and avoid direct contact with all light sources emitting ultra violet rays, or contact with fumes, solvents, fuels, lubricants, chemicals, acids, disinfectants.
- Follow Maintenance General Instruction & specific procedures to replace O Ring set as listed above.



Guide Opening Tool M-32/24  
Photo - 1



Flat Face this side  
Photo – 2



Plunger with sleeve  
Photo – 3

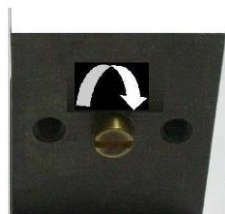

Manual Override in "OFF"  
Turn clockwise to On Valve  
Photo – 4

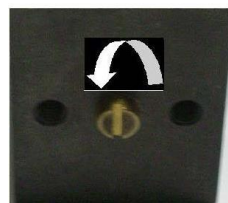

Manual Over ride in 'ON'  
Turn Anti Clockwise to 'OFF'  
Photo-5

**Contact:****ROTEX AUTOMATION LIMITED**

987/11, GIDC, MAKARPURA, VADODARA – 390010, INDIA

Tel.: +91 265 2638136, 2638746, 2638795 Fax: +91 265 2638130

E-mail: [rotexbrd@rotexautomation.com](mailto:rotexbrd@rotexautomation.com) Website: [www.rotexautomation.com](http://www.rotexautomation.com)