

**MOUNTING, OPERATING, TESTING & MAINTENANCE INSTRUCTIONS  
 FOR ROTEX 2/2 DIRECT ACTING, SOLENOID VALVE  
 3275I (NORMALLY OPEN)**

ROTEX retains all rights to this publication.

All details within this manual and the catalogue are subject to change without manner.

ROTEX will not be responsible for any damage whatsoever arising from the use of the Solenoid Valve, due to misuse or incorrect installation or misinterpretation of the information contained herein.

**SPECIFICATION OF STANDARD SOLENOID VALVE**

TYPE : 2 Port 2 Positions  
 OPERATION : DIRECT ACTING, NORMALLY OPEN, SOLENOID VALVE  
 ORIFICE = NW : 1.8mm, 2.2mm, 2.5mm, 3mm, 3.5 mm, and 4 mm  
 OPERATING PRESSURE : 0-30bar, 0-22bar, 0-20bar, 0-15bar, 0-10bar, 0-8bar,  
 MANUAL OVERRIDE : Optionally provided 15bar

**CONSTRUCTION**

Body	SS316	(B5)				
Internal	SS316					
Core Tube	SS304					
Core Plug & Plunger	SS430, Electroless Nickel Plated					
Seals	NBR (*)	EPDM (S1)	Viton (S2)			
Springs	SS302					
Manual Override	Nil	(MO)	Push Type	(M8)		
Operating Voltage	12, 24, 48, 110, 220, 240					
Current	DC, 50Hz, 60Hz					

**IDENTIFICATION ON THE SOLENOID VALVE**

**a) VALVE LABEL**

Label on the ROTEX Solenoid Valve shows the following details:

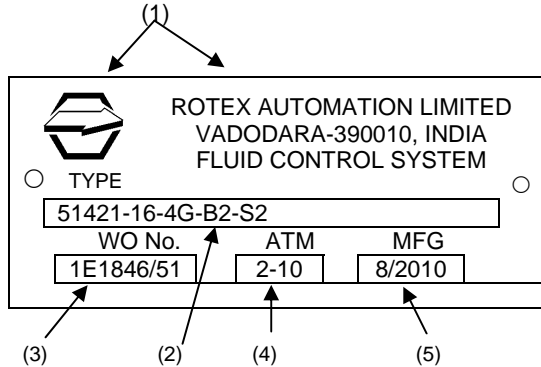

- (1) Logo + Manufacturer's Name & address
- (2) Valve Type / Code  
 51421 = Valve Model  
 Suffix = Nil  
 16 = Orifice  
 4G = 3/8" Port Connection (BSP)  
 B2 = Body Material (BRASS)  
 S2 = Seal Material (Viton)  
 - = Manual Override (Push & Turn)  
 110V = Solenoid Voltage  
 50Hz = Current (AC)  
 22 = Solenoid Construction  
 = (Enclosure : Plug In)  
 H = Solenoid Class 'H' Insulation  
 Sp. Version = Nil
- (3) Manufacturer's Work Order reference / Sr. No. of the Valve
- (4) Operating Pressure
- (5) Manufacturing Month & Year
- (6) Valve Symbol
- (7) Media
- (8) ATEX Ex mark for Valve (Non Electrical Part)
- (9) "CE" mark for ATEX and/or PED compliance.

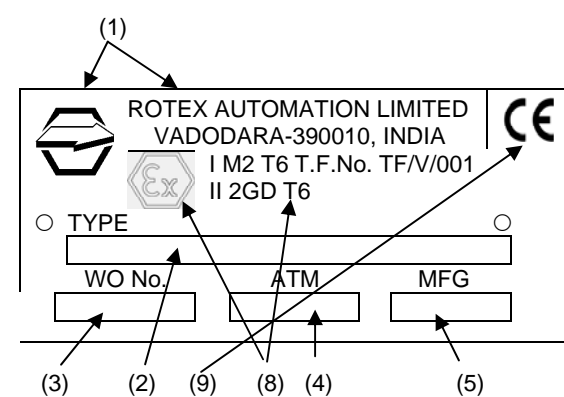
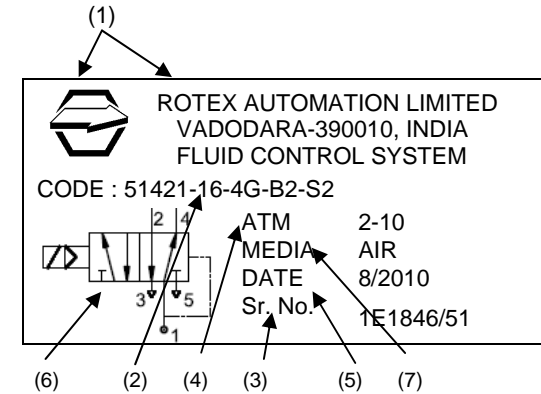

**b) SOLENOID LABEL**

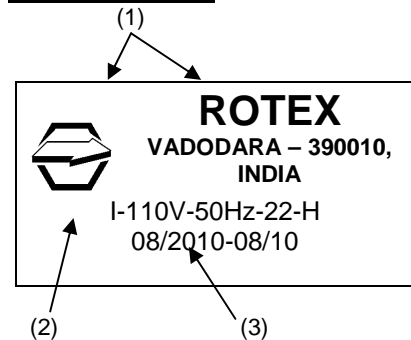

- (1) Logo + Name of the Manufacturer
- (2) Solenoid Type  
 I = Solenoid Size I  
 110V = Solenoid Voltage  
 50 Hz = Solenoid Current  
 22 = Solenoid Construction (Plug In DIN)  
 H = Solenoid Class H Insulation
- (3) Plan No. & Manufacturing Month / Year

c) **PORT IDENTIFICATION**

A solenoid Valve with NPT (F) threading is normally marked “N” near the port and with Metric threads are marked “M”. For ports with BSP threads, there is no marking.

d) Voltage, current & other details are additionally marked/punched on the solenoid.

**⚠ NOTE: The product without label is out of warranty and risk.**

**CONNECTIONS**

VALVE TYPE	Inlet	Outlet
3275I	2	1

**A) OPERATING PRINCIPLE**

In de-energized condition of the solenoid, plunger support to bottom disc to keeps downwards and. In this state Inlet Port # 2 and Outlet port # 1 are connected so, when we applied the pressure from Inlet port # 2, media come out from Outlet port # 1 through bottom Duse hole.

In energized condition of the solenoid plunger and bottom disc moves up so, bottom Duse hole blocked by bottom disc in this state, Inlet port # 2 and Outlet port # 1 are disconnected. So, media not come out from the Outlet port # 1.

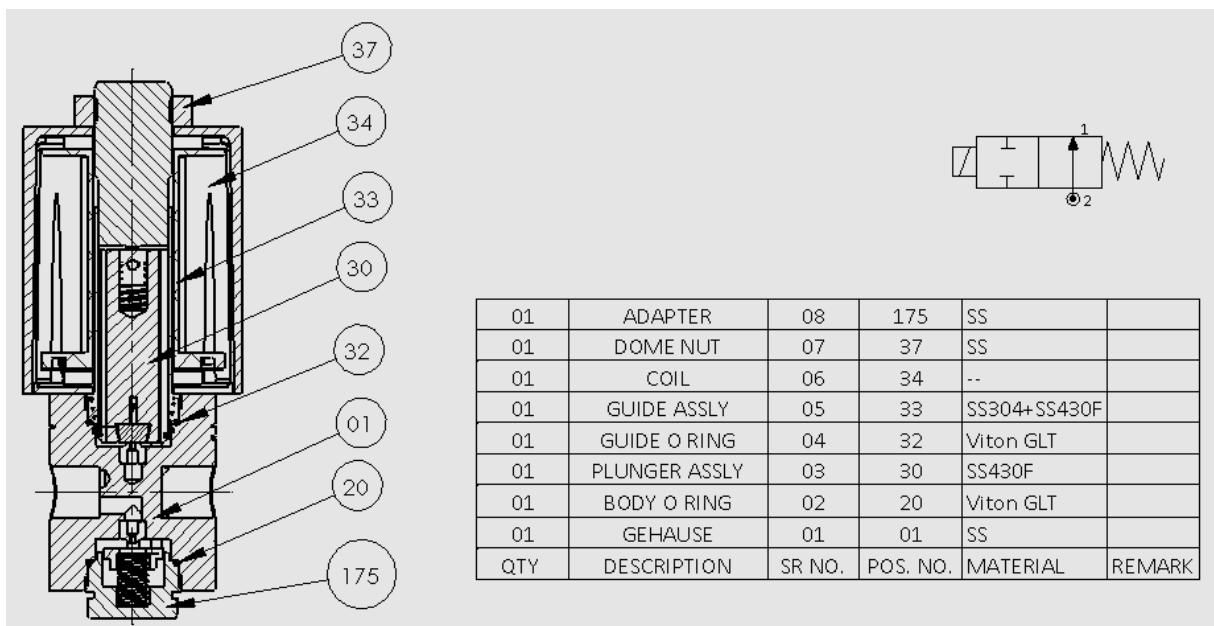

**3275I**



**(B) MOUNTING/INSTALLATION PROCEDURE:**

1. ENSURE THAT:

- a) While storing, keep the valve in cool, dry, dust free area.
- b) On receipt of the valve, in case if the same is to be removed from the sealed plastic bag for inspection/testing, put them back with dust plugs on its ports and sealing the plastic bag as soon as the inspection/testing is over.
- c) The valve should be removed from its card board and/or plastic bag just before the installation.
- d) Flush lines before installing the valve.

- e) To avoid pressure drop and to achieve optimum parameters, Pipe / Tube / Fitting from the source of pressure to the valve and to the connected equipment should have ID which is  $\geq$  NW (Orifice) of the valve.
  - f) To avoid pressure drop, if more than one valve is being operated simultaneously from a common header, then minimum ID of the header can be calculated as under.  
ID Header =  $\sqrt{(NW^2 \times n)}$   
n = Number of Valves operating at a time and which are connected to a common header,  
NW = Orifice of the Valve.
  - g) Incorporate filter in the line to avoid hard particles entering into the valve.
  - h) Do not try to drill any additional holes or machine, modify any of the valve components.
  - i) Inlet pressure does not exceed rated pressure.
  - j) Hemp-Filaments, 'Jute' or even Teflon-Ribbons are normally not required, as the port connections of ROTEX Valve is accurately machined.
  - k) Do not cover first two thread pitches with Teflon tape or sealant. To avoid over lap of the Teflon ribbon or cuts generated while tightening, getting carried away into the valve.
  - l) For Solenoid Valve to be installed in European Union, check the applicability for ATEX, PED Directives. Refers separate Instruction Manual for ATEX approved Solenoid Valve.**
2. Provide Dust Cap on the exhaust port or ensure that the valve is mounted such a way that dust particles / Rain water / process fluid do not enter into the valve through exhaust port of the valve. You can Connect bend pipe of ID  $\geq$  NW of the valve so that the exhaust port is not directly (straight) open into the atmosphere.
  3. The process fluid etc. do not fall on the valve body.
  4. Install valve in such a way that the rain water / other process fluid dripping along the cable does not fall On the SOV and has no possibility to run along the cable and enter into the Terminal area.
  5. in case if the valve is installed in potentially hazardous area, check for the temperature class of the Solenoid to avoid explosion due to heated Solenoid / other components.
  6. Provide fuse of proper rating to avoid excess current passing through the Solenoid and thereby avoiding Overheating.
  7. It is not likely however; the user is advised to protect the valve against lightening as the same is not Assessed.
  8. Check internal components (wetted) parts for its compatibility with fluid passing through the valve.
  9. **It is recommended to replace all the Rubber Parts including Plunger Assembly (Repair Kit – Code 99) in case if the valve is to be installed and put in service after 2 years from the date of manufacture.**

#### **ELECTRICAL**

1. Verify name plate affixed on the Solenoid.
2. Connect the power supply according to the voltage rating of the Solenoid
3. Ensure that the cover of Junction Box/Terminal Box is properly tightened wherever applicable.
4. Install valve in such a way that the rain water / other process fluid dripping along the cable does not fall on the SOV and has no possibility to run along the cable and enter into the Terminal area.
5. Fill in the space between cable and gland entry with a proper sealant. If necessary, you may mount the valve upside down or in any other direction.
6. Ensure that the Solenoid enclosure meets process and local authority requirement.
7. The Plug In, Terminal Box, FPJB, IS Solenoids are provided with test leads. Remove them before final installation.
-  8. Check for proper connections for the Solenoid which are polarity sensitive e.g. (a) Latched Solenoid (b) EEx ia Solenoid.
-  9. **Refer separate manual for construction of the Solenoid and for specific instructions related to Solenoid e.g. (a) EEx ia (b) Latched Solenoid (c) EExd Solenoid IP 67, IP 54**
10. Ensure that the solenoid construction is selected properly meeting the environment in which the valve is supposed to be installed e.g. use of Exd or Ex ia solenoid for valve to be installed in hazardous location or Weatherproof Solenoid having IP 67 for outdoor installation.

#### **MANUAL OVERRIDE OPERATION**

- (A) **PUSH AND TURN MA WITH KNOB**  
In normal position of the manual actuator, when we applied the pressure at Inlet port # 1, media pass from bottom Duse to outlet port # 2, in this state inlet port # 1 and Outlet port # 2 are connected. Thus media come out. To operate manual actuator, turn manual actuator / Lever clockwise and locked, so plunger move up, simultaneously bottom disc also move up, and bottom Duse hole blocked by bottom disc, in this state inlet port # 1 and outlet ports # 2 are disconnected, thus media cannot come out. Bring the valve in original position unlocked & turn manual actuator / Lever in anti clockwise.

**(B) PUSH MA WITH KNOB**

In normal position of the manual actuator, when we applied the pressure at Inlet port # 1, media pass from bottom Duse to outlet port # 2, in this state inlet port # 1and Outlet port # 2are disconnected. Thus media come out. To operate manual actuator, push manual actuator / Lever, so plunger move up, simultaneously bottom disc also move up, and bottom Duse hole blocked by bottom disc, in this state inlet port # 1 and outlet ports # 2 are disconnected, thus media cannot come out. Bring the valve in original position released the manual acuter / lever.

**TESTING OF THE VALVE AT THE TEST BENCH**

- ⚠ Check at least once in 3 years or following your routine maintenance schedule.
  - a) Apply rated pressure at inlet port of the valve.
  - b) Plug outlet ports.
  - c) Check operation of the valve and leakage at the exhaust ports and pilot vent at the rated and minimum working pressure by applying 75% to 120% rated voltage.
  - d) While keeping the solenoid de-energized, check operation and leakage from exhaust and pilot vent ports of the valve at the rated and minimum working pressure by operating Manual Override.
  - e) While keeping the solenoid energized, check operation and leakage from exhaust and pilot vent ports of the valve at the rated and minimum working pressure by operating Manual Override.
  - ⚠ f) Without connecting air supply to the valve, operate Manual Override. Energize and De-energize Solenoid to check for the plunger movement (normally movement should not be there) which can be checked by click sound. After operating Manual Override if plunger movement is found, reduce length of the manual override by 0.3mm from its taper end. Continue this till click sound stops.
  - g) Check the insulation resistance of the Solenoid by applying 500V DC at terminals and the solenoid housing. It should be more than 100 Mega Ohms.

**RECOMMENDED SPARES**

- a) Seal Kit (O Ring) (Code – 98).
- b) Plunger assembly (Part No. 30).
- c) Spare Solenoid. (Code – 34)
- d) Repair Kit (Code – 99)

**SPARE ORDERING CODE**

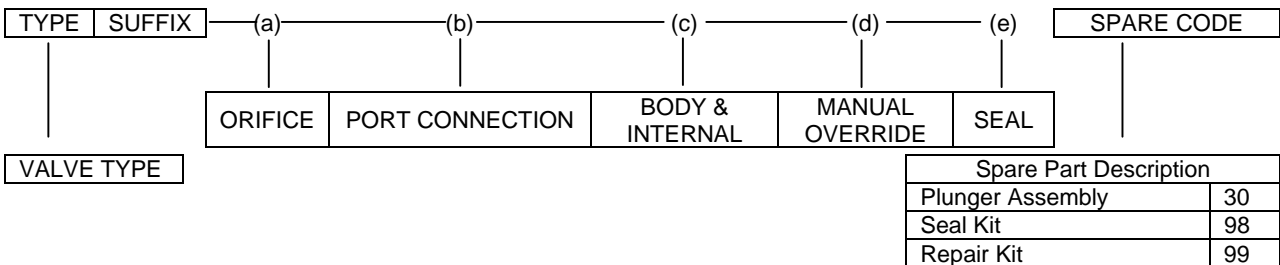

**RECOMMENDED MAINTENANCE**

- Replacement of Complete Set of O Ring ... ..  
 - Solenoid O Ring, Guide O Ring (Part 32),  
 - MA O Ring, Body O Ring (Part 20),
- Replacement of Plunger Assembly ... ..
- Replacement of the Solenoid ... ..
- Check of Insulation Resistance, Resistance of the Solenoid...
- Check Resistance of the Solenoid... ..  
 (Not applicable for Solenoid with IS, RC options or AC Solenoid with ≥ 11 Watt power).

**PREVENTIVE**

- Once in 5 years or 2 million operations.
- Once in 5 years or 2 million operations
- As and when required.
- Once in a year (should be ≥ 100 M Ohms @ 500VDC.
- Replace Solenoid if the resistance reduces more than 5% computed at 20°C as compared to its Initial value.

**MAINTENANCE – GENERAL INSTRUCTION**

- The Solenoid Valve must be removed from the site and has to be maintained under safe conditions.
- ⚠ • All air and electrical connections must be switched off before removing valve from the line.
- ⚠ • It is recommended to replace complete set of O Ring even if one of the O Ring is damaged. This is to ensure trouble free operation of the valve and will avoid its premature failure.
- Using Grease other than Silicon base Molykote 33M will lead to premature failure of O Rings of the **ROTEX** Solenoid valve.

- ⚠ • If necessary to clean the components, **do not use Kerosene, Diesel, Petrol to clean valve as this damages the O Rings and other rubber material. Instead use light Detergent Soap Solution.**
- Ensure that the components are free from dust, dirt, lint and metal burrs.
- Twisting of O Ring should be avoided. Ensure that the twist is removed before fitting matching part.
- While closing the matching part, the matching part should be pushed in a straight line. Turning motion should be avoided.
- Pinching of O Ring at the groove corner at the time of closing gland should be avoided.
- User is requested to use safe practice for maintenance.
- It is important to place the dismantled Valve Parts on a clean paper or cloth in same sequence in which you have dismantled them.
- Ensure to keep all the components of the valve separately to avoid their mixing up. The component appears to be same may have small differences which will cause malfunction if interchanged.
- In case of difficulty you should contact the Agent, Distributor or **ROTEX** directly.
- Using **ROTEX** genuine spares will **guarantee** you trouble free operation and will avoid premature failure.

(A) **TO REPLACE SOLENOID**

- 1) Open dome nut (Part 37) and pull out solenoid (Part 34)
- 2) Replace new solenoid ensuring the construction, voltage and current meets the requirements.
- 3) Tighten the dome nut (Part 37) applying torque of 0.2 kgm to 0.35 kgm to avoid over tightening of the solenoid.
- 4) Measure and record resistance of the Solenoid.

(B) **TO REPLACE GUIDE ASSEMBLY (CORE TUBE) (Part 33) / PLUNGER (Part 30)**

- 1) Open dome nut (Part 37) and pull out solenoid (Part 34).
- 2) Open Guide Assembly (Core Tube) (Part 33).
- 3) Remove Plunger Assembly (Part 30).
- 4) Replace the necessary defective parts ensuring that the plunger assembly spring and the retaining ring is as per Photo – 1 or as per Photo – 2 & 3.
- 5) The Plunger as per Photo – 2 & 3 is interchangeable and can be fitted in the existing Guide Assembly (Core Tube).
- 6) Fix Guide Assembly (Core Tube) using correct tool.
- 7) Fix the solenoid and dome nut as per Point-4 of procedure A.
- 8) Even though it is not recommended, in case if required, the Guide Assembly (Core Tube) (Part 33) can be opened using pliers or other similar tool ensuring that the same does not damage anything or component and the pliers is tighten above weld joint (weld joint should be at the centre of plier jaw width).

(C) **REPLACEMENT OF MANUAL OVERRIDE (PART 8)**

- 1) Remove Grub Hex Socket Set Screw and pull out Manual Override.
- 2) Replace new Manual Override applying light layer of Silicon Grease Molykote 33M and tighten the grub screw fully till the Manual Override stops traveling in and out.
- 3) Open the Grub Hex Socket Set Screw slightly (1/4 turn) and check the smooth movement of the grub screw.
- ⚠ 4) Without connecting air supply to the valve, operate Manual Override. Energize and De-energize Solenoid to check for the plunger movement (normally movement should not be there) which can be checked by click sound. After operating Manual Override if plunger movement is found, reduce length of the manual override by 0.3mm from its taper end. Continue this till click sound stops.

(D) **REPLACEMENT OF O RINGS**

- 1) Remove solenoid if necessary as per Procedure (A). or bottom bush.
- 2) Remove all the "O" Rings, Body O Ring.
- 3) Fix new O Rings applying light layer of Molykote 33M grease.
- 4) Ensure that the O Rings and other rubber parts are compatible to the media passing through the valve.
- 5) Reassemble the valve.
- 6) Check operation and leakage of the valve
- 7) Contact ROTEX in case of any difficulty.

**STORING, CLEANING AND MOUNTING OF ELASTOMERS: SYNTHETIC RUBBER PRODUCTS**

- Store Plunger, O Ring Set in sealed polyethylene bag, kept in cool, dry, dust free area and avoid direct contact with all light sources emitting ultra violet rays, or contact with fumes, solvents, fuels, lubricants, chemicals, acids, disinfectants.
- Follow Maintenance General Instruction & specific procedures to replace O Ring set as listed above.

**Contact:**

**ROTEX AUTOMATION LIMITED**  
**987/11, GIDC, MAKARPURA, VADODARA – 390010, INDIA**  
**Tel.: +91 265 2638136, 2638746, 2638795 Fax: +91 265 2638130**  
**E-mail: [rotexbrd@rotexindia.com](mailto:rotexbrd@rotexindia.com) Website: [www.rotexindia.com](http://www.rotexindia.com)**