

# MOUNTING, OPERATING, TESTING & MAINTENANCE INSTRUCTIONS FOR ROTEX 5/3 INTERNAL PILOT OPERATED CENTRE OFF POPPET SOLENOID VALVE MODEL 51408

ROTEX retains all rights to this publication.

All details within this manual and the catalogue are subject to change without manner.

ROTEX will not be responsible for any damage whatsoever arising from the use of the Solenoid Valve, due to misuse or incorrect installation or misinterpretation of the information contained herein.

### CONNECTION

VALVE TYPE	Inlet	Outlet	Exhaust	Outlet	Exhaust	Pilot Vent
51408	1	2	3	4	5	6

### A) OPERATING PRINCIPLE

In de-energized condition of the solenoid, applied the pressure at Inlet port # 1, a part of media passed up to the duse hole which is blocked by plunger assembly. Remaining pressure drawn up to below the piston assembly, which is support to spring to keeps piston assembly up. In this state all ports (Inlet, Outlet and Exhaust) ports are disconnected to each other.

In energized condition of the solenoid A, plunger moves up, thus media pressure come out from respective duse hole and act on the piston assembly. In this state Inlet port # 1 and Outlet port # 2 is connected. Outlet port # 2 and Exhaust port # 3 is disconnected. Media pressure come out from Outlet port # 2. Inlet port # 1 and Outlet port # 4 is disconnected. Outlet port # 4 and Exhaust port # 5 is connected.

In energized condition of the solenoid B, plunger moves up, thus media pressure come out from respective duse hole and act on the piston assembly. In this state Inlet port # 1 and Outlet port # 4 is connected. Outlet port # 4 and Exhaust port # 3 is disconnected. Media pressure come out from Outlet port # 4. Inlet port # 1 and Outlet port # 2 is disconnected. Outlet port # 2 and Exhaust port # 3 is connected.

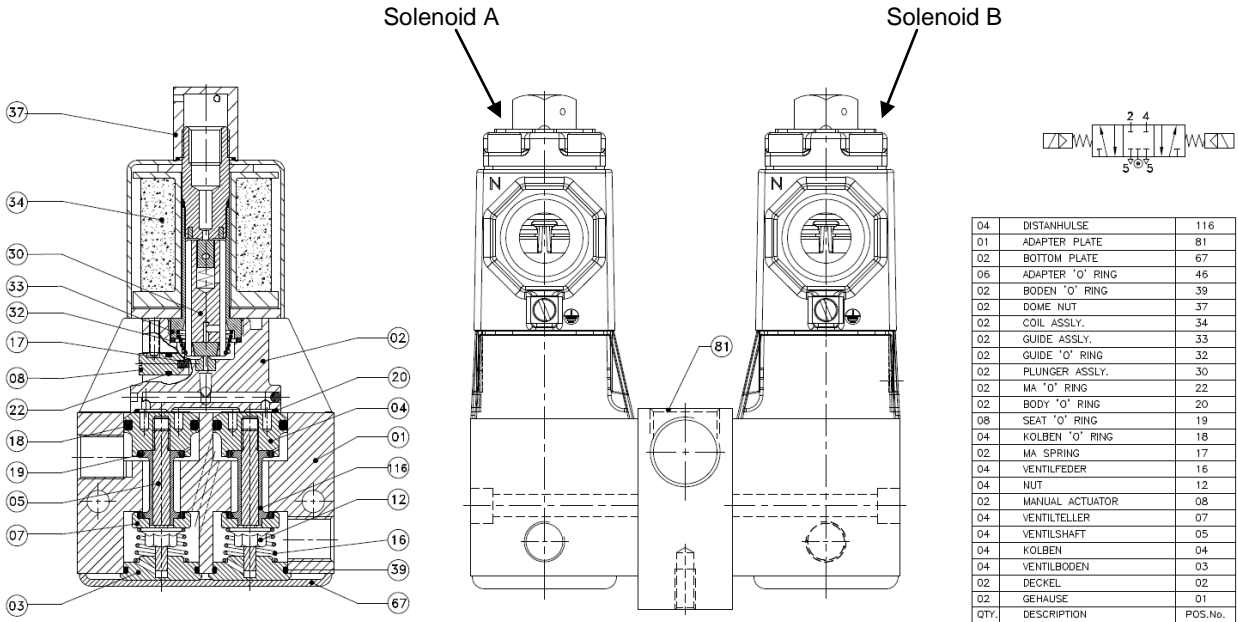

**IDENTIFICATION ON THE SOLENOID VALVE****a) VALVE MARKING**

Marking on the **ROTEX** Solenoid Valve shows the following details:

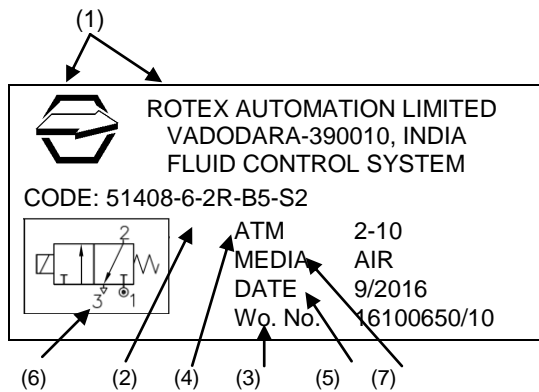

- (1) Logo + Name & address of the Manufacturer
- (2) Valve Type / Code  
51408 = Valve Model  
Suffix = Nil  
6 = Orifice  $\varnothing$   
2R = Port Connection  
B5 = Body Material  
S2 = Seal Material
- (3) Work Order reference / Sr. No. of the Valve
- (4) Operating Pressure
- (5) Month & Year of manufacture
- (6) Valve Symbol
- (7) Media

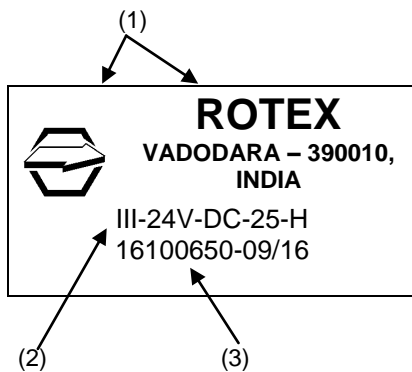
**b) SOLENOID MARKING**

- (1) Logo + Name of the Manufacturer
- (2) Solenoid Type  
III = Solenoid Size III  
24V = Solenoid Voltage  
DC = Solenoid Current  
25 = Solenoid Construction  
H = Solenoid Class H Insulation
- (3) Work order No. Manufacturing Month / Year

**c) PORT IDENTIFICATION**

A solenoid Valve with NPT (F) threading is normally marked "N" near the port and with Metric threads are marked "M". For ports with BSP threads, there is no marking.

d) Voltage, current & other details are additionally marked/punched on the solenoid.

**NOTE:** The product without marking is out of warranty and risk.



**(B) MOUNTING/INSTALLATION PROCEDURE:****1. ENSURE THAT:**

- a) While storing, keep the valve in cool, dry, dust free area.
- b) On receipt of the valve, in case if the same is to be removed from the sealed plastic bag for inspection/testing, put them back with dust plugs on its ports and sealing the plastic bag as soon as the inspection/testing is over.
- c) The valve should be removed from its card board and/or plastic bag just before the installation.
- d) Flush lines before installing the valve.
- e) To avoid pressure drop and to achieve optimum parameters, Pipe / Tube / Fitting from the source of pressure to the valve and to the connected equipment should have ID which is  $\geq$  NW (Orifice) of the valve.
- f) To avoid pressure drop, if more than one valve is being operated simultaneously from a common header, then minimum ID of the header can be calculated as under.  



$$ID \text{ Header} = \sqrt{(NW^2 \times n)}$$

$$n = \text{Number of Valves operating at a time and which are connected to a common header,}$$

$$NW = \text{Orifice of the Valve.}$$
- g) Incorporate filter in the line to avoid hard particles entering into the valve.
- h) Do not try to drill any additional holes or machine, modify any of the valve components.
- i) Inlet pressure does not exceed rated pressure.

- j) Hemp-Filaments, 'Jute' or even Teflon-Ribbons are normally not required, as the port connections of ROTEX Valve is accurately machined.
- k) Do not cover first two thread pitches with Teflon tape or sealant. To avoid over lap of the Teflon ribbon or cuts generated while tightening, getting carried away into the valve.
-  l) **For Solenoid Valve to be installed in European Union, check the applicability for ATEX, PED Directives. Refers separate Instruction Manual for ATEX approved Solenoid Valve.**
- 2. Provide Dust Cap on the exhaust port or ensure that the valve is mounted such a way that dust particles / rain water / process fluid do not enter into the valve through exhaust port of the valve. You can connect bend pipe of ID  $\geq$  NW of the valve so that the exhaust port is not directly (straight) open into the atmosphere.
- 3. The process fluid etc. does not fall on the valve body.
-  4. Install valve in such a way that the rain water / other process fluid dripping along the cable does not fall on the SOV and has no possibility to run along the cable and enter into the Terminal area.
- 5. In case if the valve is installed in potentially hazardous area, check for the temperature class of the Solenoid to avoid explosion due to heated Solenoid / other components.
- 6. Provide fuse of proper rating to avoid excess current passing through the Solenoid and thereby avoiding over heating.
- 7. It is not likely however; the user is advised to protect the valve against lightening as the same is not Assessed.
- 8. Check internal components (wetted) parts for its compatibility with fluid passing through the valve.
-  9. **It is recommended to replace all the Rubber Parts including Plunger Assembly (Repair Kit – Code 99) in case if the valve is to be installed and put in service after 2 years from the date of manufacture.**
- 10. Install valve matching Port A of the Actuator (active port) to the Port 2 of the Solenoid Valve.
- 11. 51408 can be operated with 6 Watt / 8 Watt Solenoid.

### **ELECTRICAL**

- 1. Verify marking affixed on the Solenoid.
- 2. Connect the power supply according to the voltage rating of the Solenoid
- 3. Ensure that the cover of Junction Box/Terminal Box is properly tightened wherever applicable.
- 4. Install valve in such a way that the rain water / other process fluid dripping along the cable does not fall on the SOV and has no possibility to run along the cable and enter into the Terminal area.
- 5. Fill in the space between cable and gland entry with a proper sealant. If necessary, you may mount the valve upside down or in any other direction.
- 6. Ensure that the Solenoid enclosure meets process and local authority requirement.
- 7. The Plug In, Terminal Box, FPJB, IS Solenoids are provided with test leads. Remove them before final installation.
-  8. Check for proper connections for the Solenoid which are polarity sensitive e.g. (a) Latched Solenoid (b) Ex ia Solenoid.
-  9. **Refer separate manual for construction of the Solenoid and for specific instructions related to Solenoid e.g. (a) Ex ia (b) Latched Solenoid (c) Exd Solenoid IP 67.**
- 10. Ensure that the solenoid construction is selected properly meeting the environment in which the valve is supposed to be installed e.g. use of Exd or Ex ia solenoid for valve to be installed in hazardous location or Weatherproof Solenoid having IP 67 for outdoor installation.

### **MANUAL OVERRIDE OPERATION**

#### (A) **PUSH TYPE (M8)**

In normal condition of the manual override, applied the pressure at Inlet port # 1, a part of media passed up to the duse hole which is blocked by plunger assembly. Remaining pressure drawn up to below the piston assembly, which is support to spring to keeps piston assembly up. In this state all ports (Inlet, Outlet and Exhaust) ports are disconnected to each other.

To operate the manual override of solenoid A side, push and turn clockwise, thus plunger moves up, media pressure come out from respective duse hole and act on the piston assembly. In this state Inlet port # 1 and Outlet port # 2 is connected. Outlet port # 2 and Exhaust port # 3 is disconnected. Media pressure come out from Outlet port # 2. Inlet port # 1 and Outlet port # 4 is disconnected. Outlet port # 4 and Exhaust port # 5 is connected.

To operate the manual override of solenoid B side, plunger moves up, thus media pressure come out from respective duse hole and act on the piston assembly. In this state Inlet port # 1 and Outlet port # 4 is connected. Outlet port # 4 and Exhaust port # 3 is disconnected. Media pressure come out from Outlet port # 4. Inlet port # 1 and Outlet port # 2 is disconnected. Outlet port # 2 and Exhaust port # 3 is connected.

### **TESTING OF THE VALVE AT THE TEST BENCH**

 Check at least once in 3 years or following your routine maintenance schedule.

- a) Apply rated pressure at inlet port of the valve.
- b) Plug outlet ports.

- c) Check operation of the valve and leakage at the exhaust ports and pilot vent at the rated and minimum working pressure by applying 75% to 120% rated voltage.
- d) While keeping the solenoid de-energized, check operation and leakage from exhaust and pilot vent ports of the valve at the rated and minimum working pressure by operating Manual Override.
- e) While keeping the solenoid energized, check operation and leakage from exhaust and pilot vent ports of the valve at the rated and minimum working pressure by operating Manual Override.
-  f) Without connecting air supply to the valve, operate Manual Override. Energize and De-energize Solenoid to check for the plunger movement (normally movement should not be there) which can be checked by click sound.  
After operating Manual Override if plunger movement is found, reduce length of the manual override by 0.3mm from its taper end. Continue this till click sound stops.
- g) Check the insulation resistance of the Solenoid by applying 500V DC at terminals and the solenoid housing. It should be more than 100 Mega Ohms.



**RECOMMENDED SPARES**

- a) Seal Kit (O Ring + Plunger Assembly).
- b) Spare Solenoid.
- c) Repair Kit

**RECOMMENDED MAINTENANCE**

- |                                                                                                              |                                                                                                            |
|--------------------------------------------------------------------------------------------------------------|------------------------------------------------------------------------------------------------------------|
| • Replacement of Complete Set of O Ring ... ..                                                               | Once in 5 years or 2 million operations.                                                                   |
| - Kolben O Ring, Seat O Ring, Body O Ring,<br>- MA O Ring, , Guide O Ring,<br>- Boden O Ring, Adapter O Ring |                                                                                                            |
| • Replacement of Plunger Assembly ... ..                                                                     | Once in 5 years or 2 million operations                                                                    |
| • Replacement of the Solenoid ... ..                                                                         | As and when required.                                                                                      |
| • Check of Insulation Resistance, Resistance of the Solenoid...                                              | Once in a year (should be $\geq 100$ M Ohms @ 500VDC.                                                      |
| • Check Resistance of the Solenoid... ..                                                                     | Replace Solenoid if the resistance reduces More than 5% computed at 20°C as Compared to its initial value. |

**PREVENTIVE****MAINTENANCE – GENERAL INSTRUCTION**

- The Solenoid Valve must be removed from the site and has to be maintained under safe conditions.
-  • All air and electrical connections must be switched off before removing valve from the line.
-  • It is recommended to replace complete set of O Ring even if one of the O Ring is damaged. This is to ensure trouble free operation of the valve and will avoid its premature failure.
- Using Grease other than Silicon base Molykote 55M will lead to premature failure of O Rings of the **ROTEX** Solenoid valve.
-  • If necessary to clean the components, **do not use Kerosene, Diesel, Petrol to clean valve as this damages the O Rings and other rubber material. Instead use light Detergent Soap Solution.**
- Ensure that the components are free from dust, dirt, lint and metal burrs.
- Twisting of O Ring should be avoided. Ensure that the twist is removed before fitting matching part.
- While closing the matching part, the matching part should be pushed in a straight line. Turning motion should be avoided.
- Pinching of O Ring at the groove corner at the time of closing gland should be avoided.
- User is requested to use safe practice for maintenance.
- It is important to place the dismantled Valve Parts on a clean paper or cloth in same sequence in which you have dismantled them.
- Ensure to keep all the components of the valve separately to avoid their mixing up. The component appears to be same may have small differences which will cause malfunction if interchanged.
- In case of difficulty you should contact the Agent, Distributor or **ROTEX** directly.
- Using **ROTEX** genuine spares will **guarantee** you trouble free operation and will avoid premature failure.

**(A) TO REPLACE SOLENOID**

- 1) Open dome nut and pull out solenoid.
- 2) Replace new solenoid ensuring the construction, voltage and current meets the requirements.
- 3) Tighten the dome nut applying torque of 0.2 kgm to 0.35 kgm to avoid over tightening of the solenoid.
- 4) Measure and record resistance of the Solenoid.

**(B) TO REPLACE GUIDE ASSEMBLY (CORE TUBE) / PLUNGER**

- 1) Open dome nut and pull out solenoid
- 2) Open Guide Assembly (Core Tube).
- 3) Remove Plunger Assembly.
- 4) Replace the necessary defective parts ensuring that the plunger assembly spring and the retaining ring.
- 5) The Plunger is interchangeable and can be fitted in the existing Guide Assembly (Core Tube).
- 6) Fix Guide Assembly (Core Tube) using correct tool.
- 7) Fix the solenoid and dome nut as per Point-3 of procedure A.

- 8) Even though it is not recommended, in case if required, the Guide Assembly (Core Tube) can be opened using pliers or other similar tool ensuring that the same does not damage anything or component and the pliers is tighten above weld joint (weld joint should be at the centre of plier jaw width).
- (C) **REPLACEMENT OF MANUAL OVERRIDE**
- 1) Remove Grub Hex Socket Set Screw and pull out Manual Override.
  - 2) Replace new Manual Override applying light layer of Silicon Grease Molykote 55M and tighten the grub screw fully till the Manual Override stops traveling in and out.
  - 3) Open the Grub Hex Socket Set Screw slightly (1/4 turn) and check the smooth movement of the grub screw.
  - ⚠ 4) Without connecting air supply to the valve, operate Manual Override. Energize and De-energize Solenoid to check for the plunger movement (normally movement should not be there) which can be checked by click sound. After operating Manual Override if plunger movement is found, reduce length of the manual override by 0.3mm from its taper end. Continue this till click sound stops.
- (D) **REPLACEMENT OF O RINGS**
- 1) Remove solenoid if necessary as per Procedure (A).
  - 2) Disassembled the valve and adapter plate.
  - 3) Remove Deckel (Cover) by opening four screws.
  - 4) Remove bottom plate by opening CSK Allen Head screws.
  - 5) Remove Ventilboden (Valve Bottom).
  - 6) Remove Ventilfeder (Valve Spring). Ensure that the location of the same are not interchanged.
  - 7) Open piston assembly using special tool at Kolben and open Nut.
  - 8) Pull out Ventilteller (Pressure Plate) and Kolben Assembly.
  - 9) Pull out Hulse and remove all O Rings [Piston O Ring, Seat O Ring etc...].
  - 10) Clean components.
  - 11) Fix new O Rings applying light layer of Molykot M55 grease.
  - 12) Ensure that the O Rings and other rubber parts are compatible to the media passing through the valve.
  - 13) Replace MA O Ring, Body Pilot O ring and Guide O ring following procedure "B".
  - 14) Reassemble the valve.
  - 15) Check operation and leakage of the valve.
  - 16) Contact ROTEX in case of any difficulty.
  - 17) .

### **STORING, CLEANING AND MOUNTING OF ELASTOMERS: SYNTHETIC RUBBER PRODUCTS**

- Store Plunger, O Ring Set in sealed polyethylene bag, kept in cool, dry, dust free area and avoid direct contact with all light sources emitting ultra violet rays, or contact with fumes, solvents, fuels, lubricants, chemicals, acids, disinfectants.
- Follow Maintenance General Instruction & specific procedures to replace O Ring set as listed above.



Guide Opening Tool M22  
Photo – 1



Flat Face this side  
Photo – 2



Plunger with fixed conical & cylindrical seal (Old Plunger)  
Photo – 3



Plunger with moving seal  
(New Design Plunger)  
Photo – 4



Manual Override "OFF"  
Photo-5

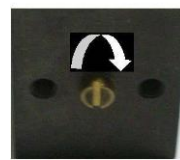

Manual Override "ON"  
Photo – 6

### **Contact:**

**ROTEX AUTOMATION LIMITED**

987/11, GIDC, MAKARPURA, VADODARA – 390010, INDIA

Tel.: +91 265 2638136, 2638746, 2638795 Fax: +91 265 2638130

E-mail: [rotexbrd@rotexautomation.com](mailto:rotexbrd@rotexautomation.com)

Website: [www.rotexautomation.com](http://www.rotexautomation.com)

